

Code: 109-7



Golden
World
Trading
Group

www.GoldenWTG.org



◆ JU-100



◆ JU-200



◆ JU-300



◆ JU-400



◆ JS-100



◆ JU-W010



◆ JU-W020



◆ JU-W030



◆ JU-W040



◆ JS-W010

THE BUSINESS

enterprise product
classification index checks to look at

企业产品分类索引查览 ▶▶

专业型门夹系列

PROFESSIONAL DOOR CLAMP SERIES

专业型地弹簧系列

PROFESSIONAL FLOOR HINGE SERIES

专业型闭门器系列

PROFESSIONAL DOOR CLOSER SERIES



中央锁系列



JU-W401



JU-W402



JU-W403



JU-W404



JU-W101



JU-W102



JU-W103



JU-W405



JU-W406



JU-W407



JU-W408



JU-W104



JU-W105



JU-W106



JU-W107



JU-W409



JU-W410



JU-W411



JU-W412



JU-W108



JU-W109



JU-W110



JU-W111



JU-121 JU-122 JU-123 JU-124 JU-125 JU-126 JU-127 JU-128



JU-228 JU-229 JU-230 JU-231 JU-232 JU-233



JU-129 JU-130 JU-131 JU-132 JU-133 JU-134 JU-135



JU-234 JU-235 JU-236 JU-237 JU-321 JU-322 JU-323



JU-221 JU-222 JU-223 JU-224 JU-225 JU-226 JU-227



JU-324 JU-325 JU-326 JU-327 JU-328

● 拉手系列

KNOBS SERIES



◆ JU-421 ◆ JU-422 ◆ JU-423 ◆ JU-424 ◆ JU-425 ◆ JU-426 ◆ JU-427



◆ JU-428 ◆ JU-429 ◆ JU-430 ◆ JU-431 ◆ JU-432 ◆ JU-433



◆ JU-434 ◆ JU-435 ◆ JU-436 ◆ JU-437 ◆ JU-438 ◆ JU-439 ◆ JU-440



PROFESSIONAL DOOR CLAMP SERIES

专业型门夹系列 ▶▶

Clamp Series PROFESSIONAL DOOR

专业型门夹系列

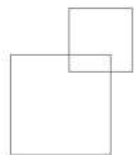

圆弧型门夹 CIRCULAR ARC DOOR CLAMP

独特的圆弧型设计，尽显典雅的欧洲品味；高强度压铸合金本体，安全耐用；特种抗氧化材料垫片；抗氧化内芯表面处理技术；适用于厚度为10mm-12mm的钢化玻璃门（或根据玻璃厚度订做）；不锈钢、铜或铝制成装饰外壳，配上镜面、砂光、钛金或根据客户订做颜色。

Unique design of arc shape with full elegant European taste. Die-cast body of alloy with high strength assures safety and durability. Pad of special oxidation resisting material. Technique of oxidation resisting inner core for surface treatment. Suitable to toughened glass doors with thickness of 10mm-12mm (or ordered on required glass thickness). Decorative case of stainless steel, bronze or aluminum with mirror surface, polishing, Titanium-golden or other colors that customer requires.



● JU-100



● JU-200



● JU-300



● JU-400



● JS-100

■ 即施妥专业系列玻璃门夹是开达五金装饰有限公司生产的高级装饰五金配件之一，产品外形美观，适用于宾馆、商场、写字楼的普通及钢化玻璃门。

性能指标(及型号)

产品特性

所有关键部件都是以高强度锌铝合金制成，符合国家轻工局建筑五金质量监督检测中心检测标准。产品耐用，安全可靠。

表面处理有不锈钢镜光、不锈钢砂光、不锈钢钛金及根据客户的要求，提供多种颜色处理选择。

配备多种型号的上夹胶圈、下夹头，适应各种安装要求。

产品系列

- 圆弧型门夹
JU-100下夹、JU-200上夹、JU-300顶夹、JU-400圆接夹、JS-100锁夹
- 方型门夹
JU-010下夹、JU-020上夹、JU-030顶夹、JU-040曲夹、JS-010锁夹
- 异型门夹
JU-480 F夹、JU-490 T夹……
- 长门夹
JU-10下方、JU-20上方

JUSTOR series glass door clamp is one of the high grade decoration hardware accessories manufactured by KAIDA Hardware Decoration Limited Company. Our products have artistic external form, suitable for the ordinary and toughened glass door of hotel, department store, and office building.

Performance quota (and model)

Product characteristic

All key spare parts are made of high strength alloy of zinc and aluminum, accord with the inspection standard set by National Light Industry Bureau Construction Hardware Quality Supervising and Inspection Center.

Surface disposal consists of mirror polishing, sand polishing, and titanium plating stainless steel, or other kinds on clients' requirements. We provide many kinds of color disposed for chosen.

Equipped manifold models of upper clamps and lower clamps, adapt to various installation requirements

Product series

- Circular Arc Door Clamp
JU-100 lower clamp, JU-200 upper clamp, JU-300 top clamp, JU-400 circular connection clamp, JS-100 lock clamp
- Square Door Clamp
JU-010 lower clamp, JU-020 upper clamp, JU-030 top clamp, JU-040 curved clamp, JS-010 lock clamp
- Special-shaped Door Clamp
JU-480F clamp, JU-490T clamp
- Rectangle Door Clamp
JU-10 lower clamp, JU-20 upper clamp

● 圆弧型门夹门扇式样

CIRCULAR ARC DOOR CLAMP AND DOOR LEAF

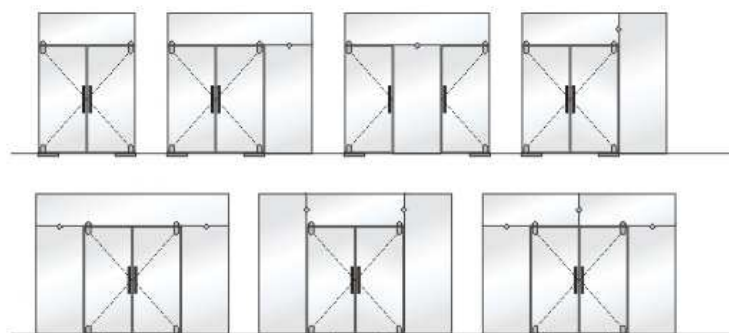
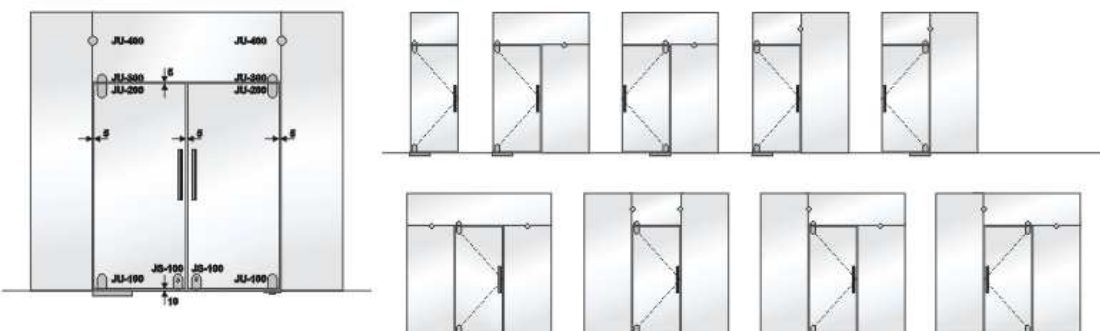
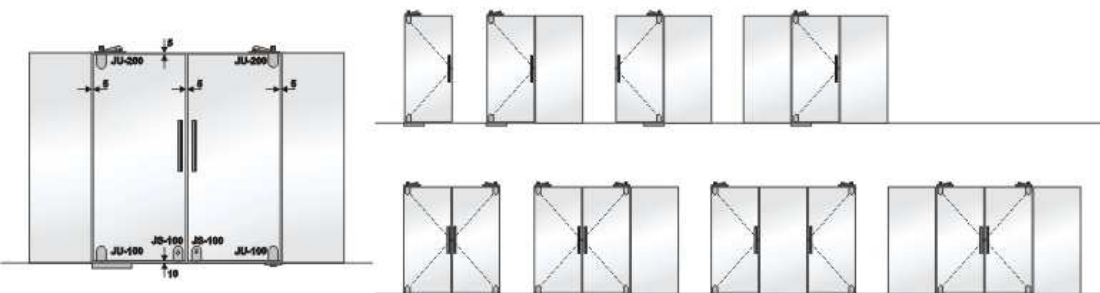

■ JU-100

- 备有不同规格的下夹头，可与多玛、盖泽、新星、邦高、皇冠等地弹簧配合使用。
- Lower clamping head of various specifications are available and can be used in conjunction with springs from DORMA, GEZE, NEWSTAR, BONGO, CROWN and etc.

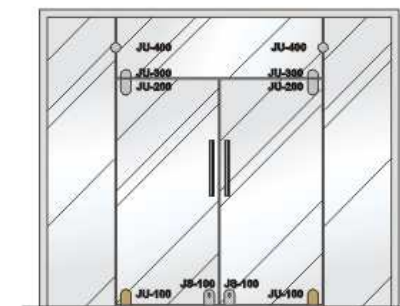
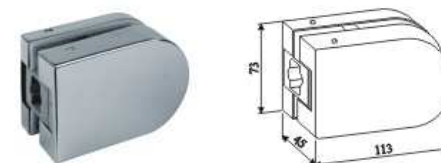

■ JU-200

- 备有不同规格的上夹套，可与多玛、盖泽、新星、邦高、皇冠等地弹簧配合使用。
- Upper clamping jackets of various specifications are available and can be used in conjunction with springs from DORMA, GEZE, NEWSTAR, BONGO, CROWN and etc.

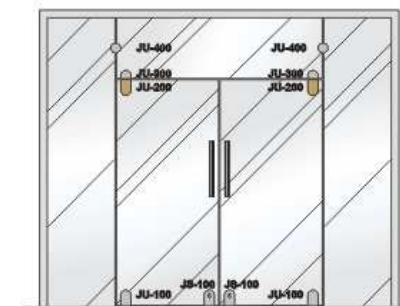
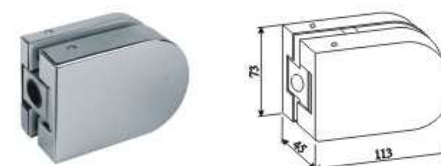

■ JU-300

- 备有不同规格的顶夹头，可与多玛、盖泽、新星、邦高、皇冠等地弹簧配合使用。
- Upper clamping head of various specifications are available and can be used in conjunction with springs from DORMA, GEZE, NEWSTAR, BONGO, CROWN and etc.

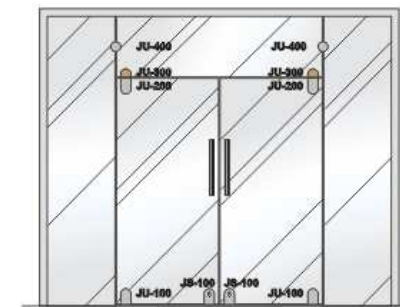
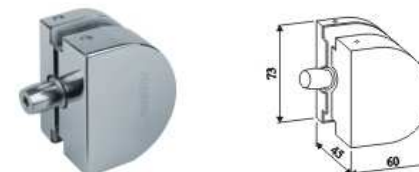

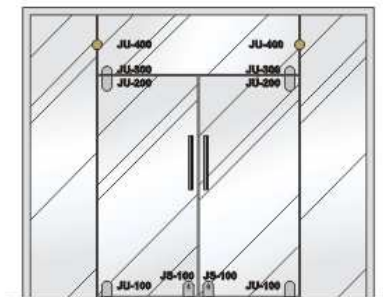
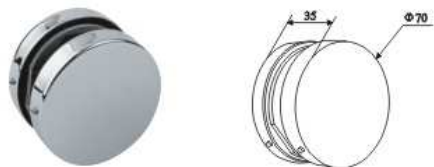
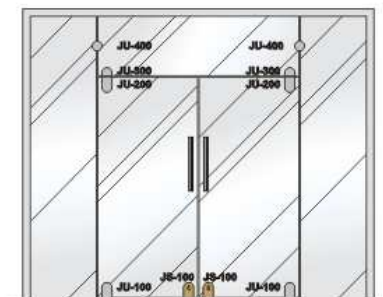
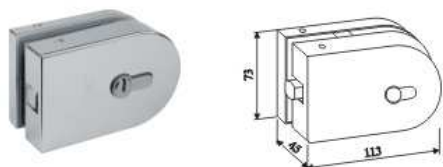
JU-400

JS-100

方型门夹
 SQUARE DOOR CLAMP

高强度压铸合金本体，安全耐用；装饰外壳采用不锈钢、铜或铝板精密冲压而成；特种抗氧化材料垫片；适用于厚度为10mm-12mm的钢化玻璃，璃门（或根据玻璃厚度订做）；表面处理颜色：镜面、砂光、钛金或根据客户订做颜色

Die-cast body of alloy with high strength assures safety and durability. Decorative case punched precisely of stainless steel, bronze or aluminum sheet. Pad of special oxidation resisting material. Suitable to toughened glass doors with thickness of 10mm-12mm (or ordered on required glass thickness). Color for surface treatment: mirror surface, polishing, Titanium-golden or other colors that customer requires.



JU-W010



JU-W020



JU-W030



JU-W040

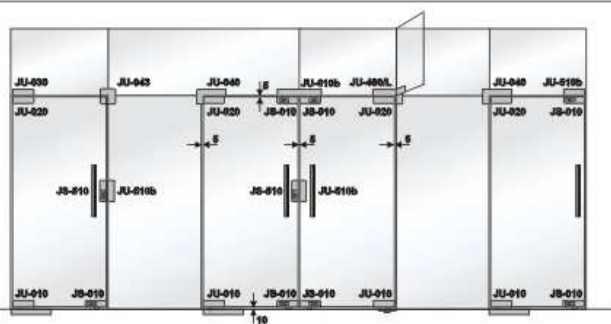
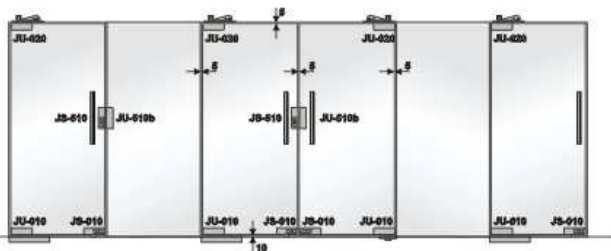

JS-W010

JUSTOR方型、异型门夹门扇式样
SQUARE & SPECIAL-SHAPED DOOR CLAMP AND DOOR LEAF

JU-W010

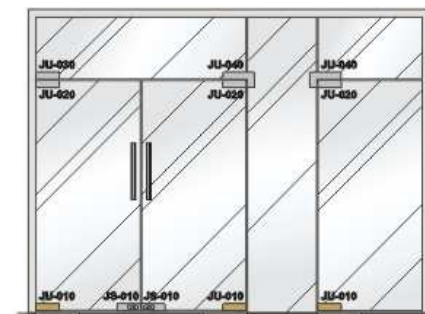
- 备有不同规格的下夹头，可与多玛、盖泽、新星、邦高、皇冠等地弹簧配合使用。
- Lower clamping head of various specifications are available and can be used in conjunction with springs from DORMA, GEZE, NEWSTAR, BONGO, CROWN and etc.

JU-W020

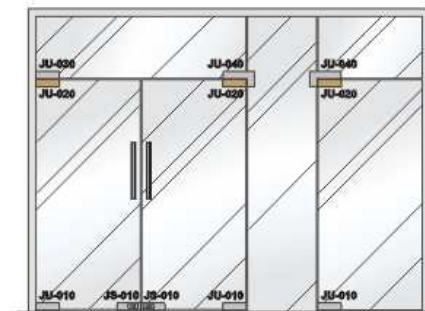
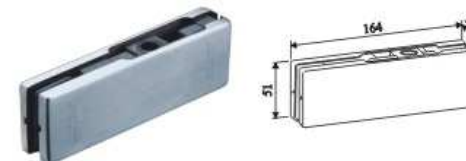
- 备有不同规格的上夹套，可与多玛、盖泽、新星、邦高、皇冠等地弹簧配合使用。
- Upper clamping jackets of various specifications are available and can be used in conjunction with springs from DORMA, GEZE, NEWSTAR, BONGO, CROWN and etc.

JU-W030

- 备有不同规格的顶夹头，可与多玛、盖泽、新星、邦高、皇冠等地弹簧配合使用。
- Upper clamping head of various specifications are available and can be used in conjunction with springs from DORMA, GEZE, NEWSTAR, BONGO, CROWN and etc.

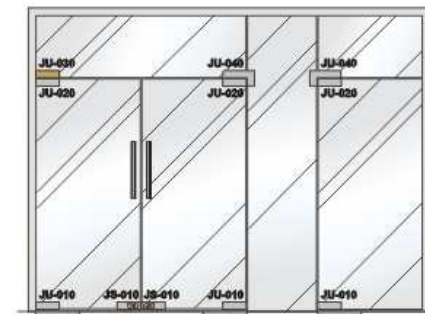

JUTOR方型门夹

JUTOR SQUARE DOOR CLAMP

JU-W040

- 备有不同规格的顶夹头，可与多玛、盖泽、新星、邦高、皇冠等地弹簧配合使用。

Upper clamping head of various specifications are available and can be used in conjunction with springs from DORMA, GEZE, NEWSTAR, BONGO, CROWN and etc.

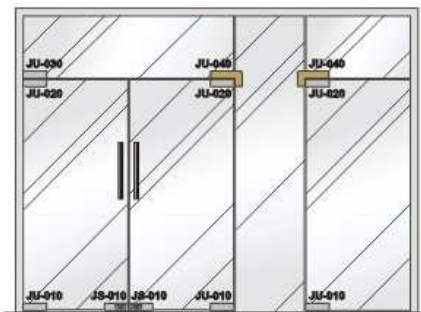
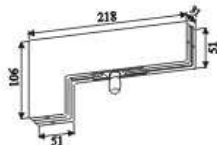
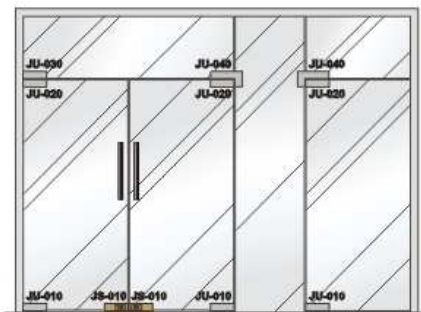
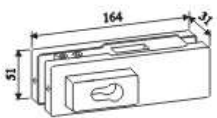
JS-W010

**异型门夹
SPECIAL-SHAPED DOOR CLAMP**

独特的圆弧型设计，尽显典雅的欧洲品味；高强度压铸铝合金本体，安全耐用；特种抗氧化材料垫片；抗氧化内芯表面处理技术；适用于厚度为10mm-12mm的钢化玻璃门（或根据玻璃厚度订做）；不锈钢、铜或铝制成装饰外壳，配上镜面、砂光、钛金或根据客户订做颜色。

Unique design of arc shape with full elegant European taste. Die-cast body of alloy with high strength assures safety and durability. Pad of special oxidation resisting material. Technique of oxidation resisting inner core for surface treatment. Suitable to toughened glass doors with thickness of 10mm-12mm (or ordered on required glass thickness). Decorative case of stainless steel, bronze or aluminum with mirror surface, polishing, Titanium-golden or other colors that customer requires.

◆ JU-610b



◆ JU-620b



◆ JU-630b



◆ JS-120



◆ JU-120b



◆ JS-130



◆ JU-130b



◆ JU-210b



◆ JU-220



◆ JS-510



◆ JU-510b



◆ JS-520



◆ JS-530



◆ JU-010b



◆ JU-410



◆ JU-470



◆ JU-420



◆ JU-480/R



◆ JU-430



◆ JU-480/L



◆ JU-450



◆ JU-490



◆ JU-460

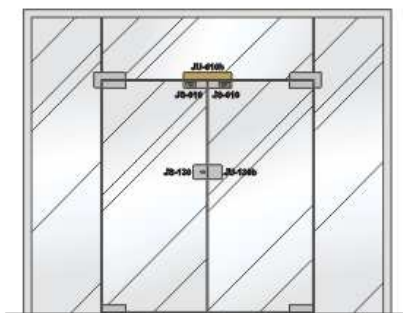
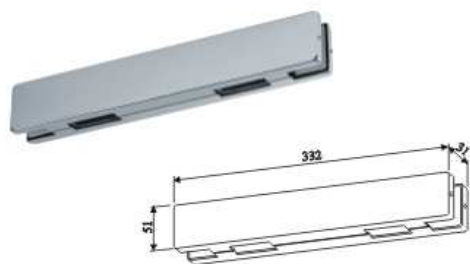

JU-610b

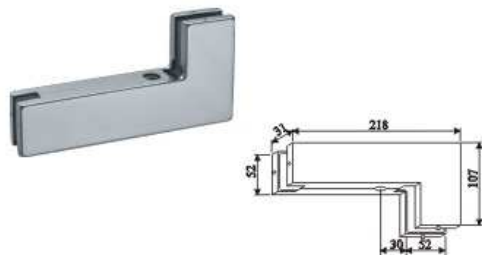
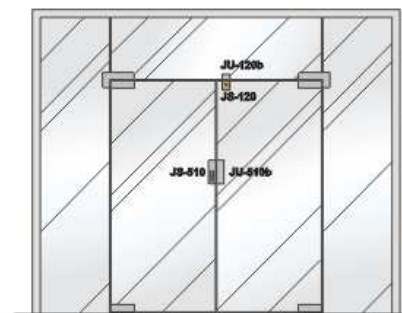
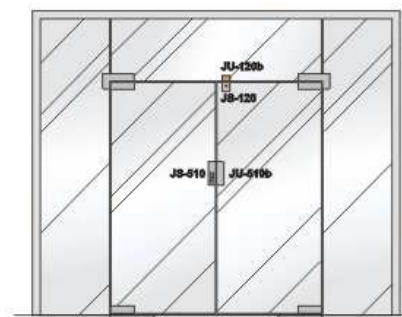
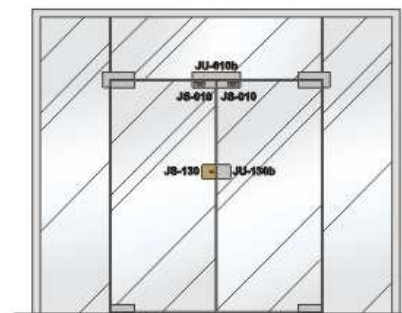
JU-620b

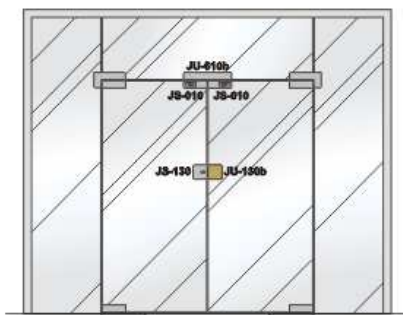
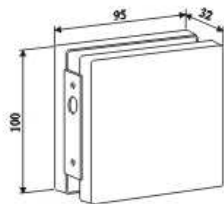
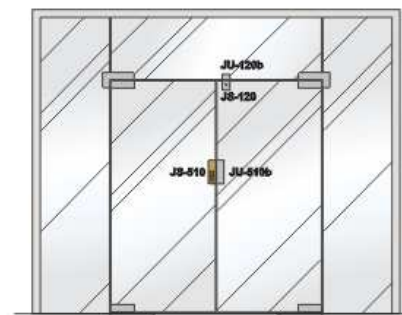
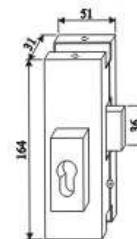
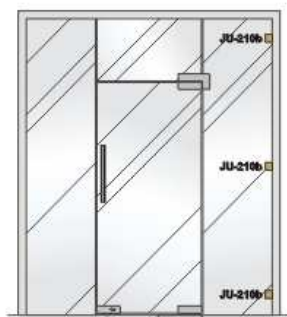
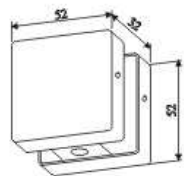
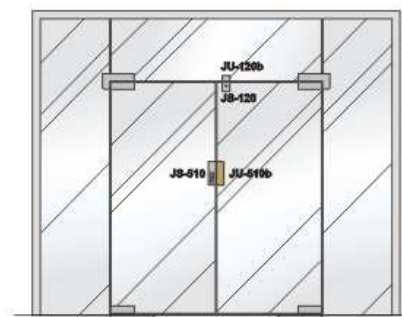
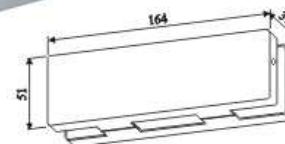
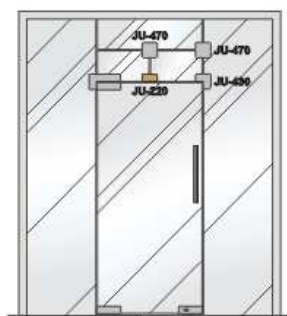
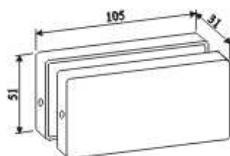
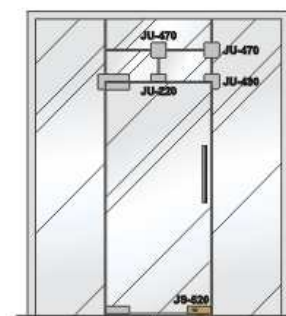
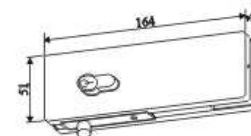
JU-630b

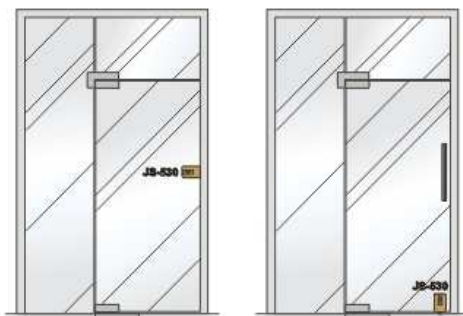
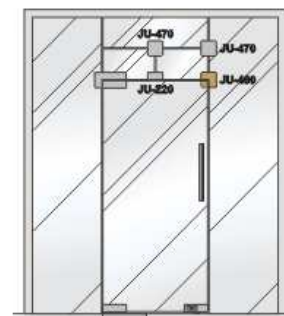
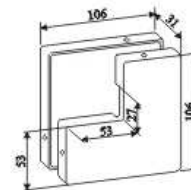
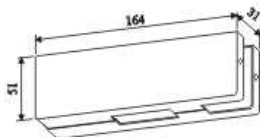
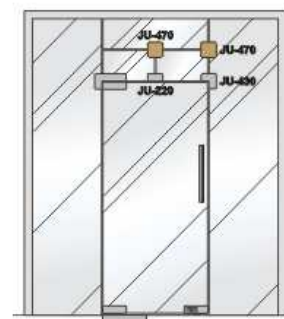
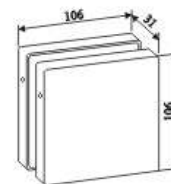
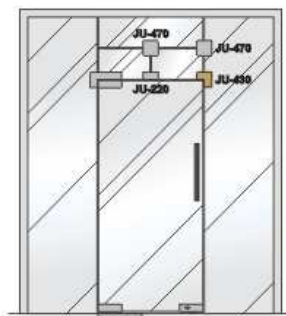
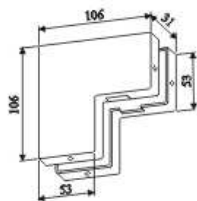
JS-120

JU-120b

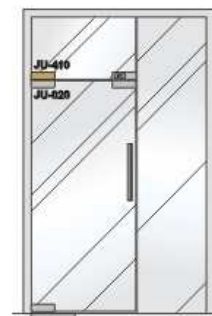
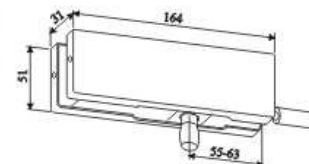
JS-130

JU-130b

JS-510

JU-210b

JU-510b

JU-220

JS-520

JS-530

JU-460

JU-010b

JU-470

JU-430

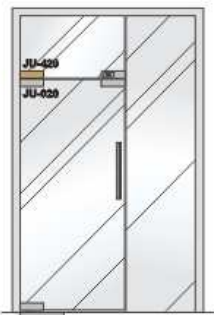
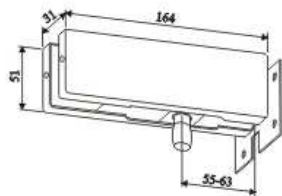
JU-410

- 备有不同规格的顶夹头，可与多玛、盖泽、新星、邦高、皇冠等地弹簧配合使用。
- Upper clamping head of various specifications are available and can be used in conjunction with springs from DORMA, GEZE, NEWSTAR, BONGO, CROWN and etc.



JU-420

- 备有不同规格的顶夹头，可与多玛、盖泽、新星、邦高、皇冠等地弹簧配合使用。
- Upper clamping head of various specifications are available and can be used in conjunction with springs from DORMA, GEZE, NEWSTAR, BONGO, CROWN and etc.

JU-450

- 备有不同规格的顶夹头，可与多玛、盖泽、新星、邦高、皇冠等地弹簧配合使用。
- Upper clamping head of various specifications are available and can be used in conjunction with springs from DORMA, GEZE, NEWSTAR, BONGO, CROWN and etc.

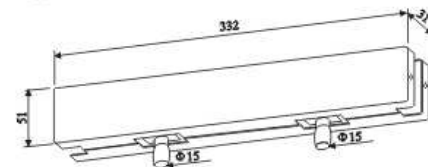
JU-480/R

- 备有不同规格的顶夹头，可与多玛、盖泽、新星、邦高、皇冠等地弹簧配合使用。
- Upper clamping head of various specifications are available and can be used in conjunction with springs from DORMA, GEZE, NEWSTAR, BONGO, CROWN and etc.

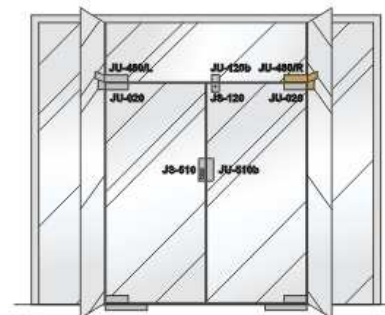
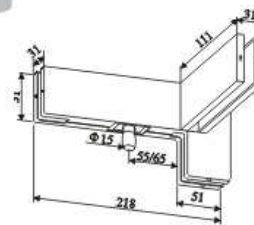
JU-480/L

- 备有不同规格的顶夹头，可与多玛、盖泽、新星、邦高、皇冠等地弹簧配合使用。
- Upper clamping head of various specifications are available and can be used in conjunction with springs from DORMA, GEZE, NEWSTAR, BONGO, CROWN and etc.

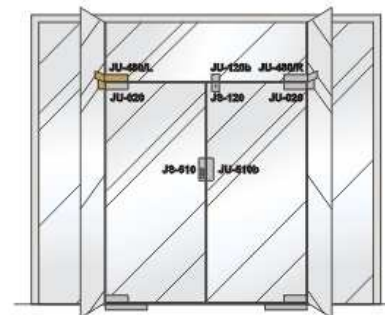
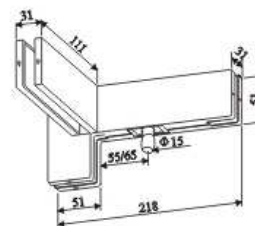

● JUSTOR异型门夹
 SPECIAL-SHAPED DOOR CLAMP

■ JU-490

- 备有不同规格的顶夹头，可与多玛、盖泽、新星、邦高、皇冠等地弹簧配合使用。
- Upper clamping head of various specifications are available and can be used in conjunction with springs from DORMA, GEZE, NEWSTAR, BONGO, CROWN and etc.

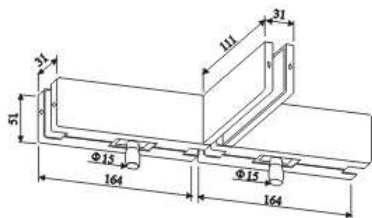

长型门夹
 RECTANGLE DOOR CLAMP

选用优质铝合金型材为内芯，装饰外壳采用进口不锈钢板精密折边而成高度仅65mm；表面处理颜色：镜面、砂光、钛金或根据客户订做颜色。

Quality Aluminum alloy section is used as inner core, Decorative case is made of imported stainless steel sheet with precise edge fold in height of 65mm only. Color for surface treatment: minute surface, polishing, Titanium-golden or other colors that customer requires.



● JU-10



● JU-20



JUSTOR长型门夹

RECTANGLE DOOR CLAMP

JU-10

- 备有不同规格的下夹头，可与多玛、盖泽、新星、邦高、皇冠等地弹簧配合使用。
- Lower clamping head of various specifications are available and can be used in conjunction with springs from DORMA, GEZE, NEWSTAR, BONGO, CROWN and etc.

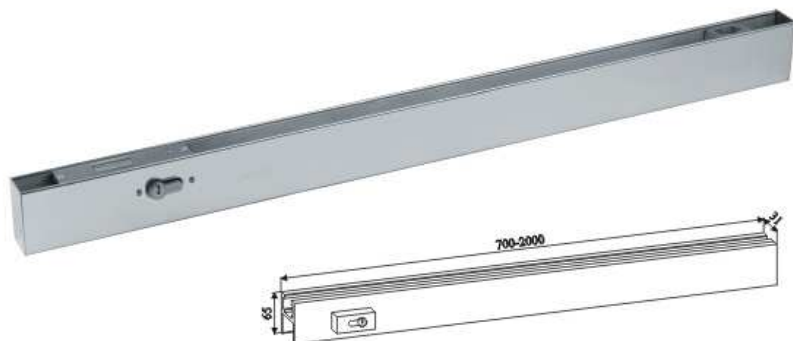
JU-20

- 备有不同规格的上夹套，可与多玛、盖泽、新星、邦高、皇冠等地弹簧配合使用。
- Upper clamping jackets of various specifications are available and can be used in conjunction with springs from DORMA, GEZE, NEWSTAR, BONGO, CROWN and etc.

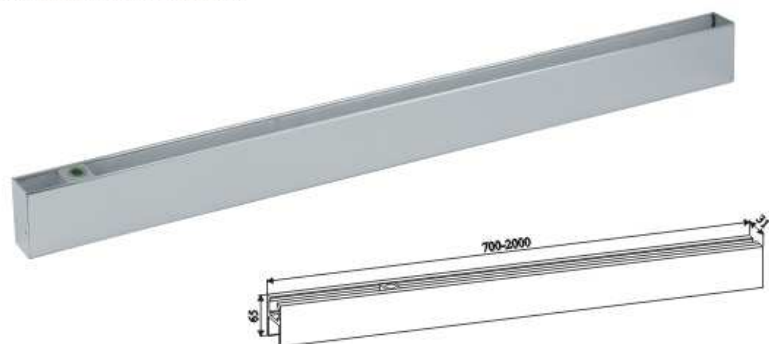
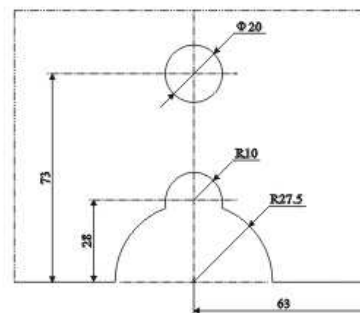
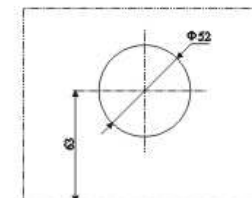
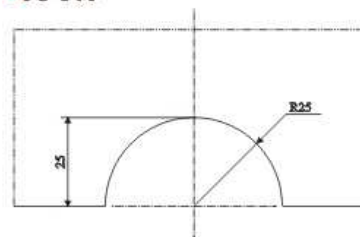
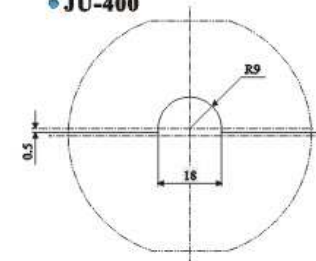
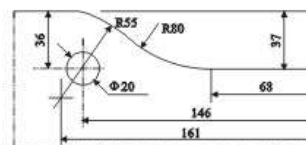
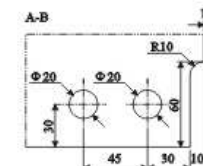
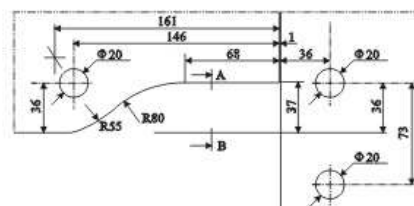
JU-100 JU-200

JS-100

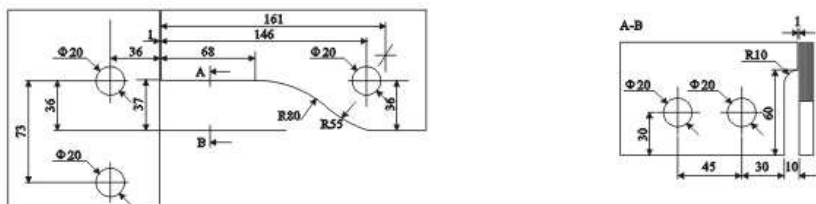
JU-300

JU-400

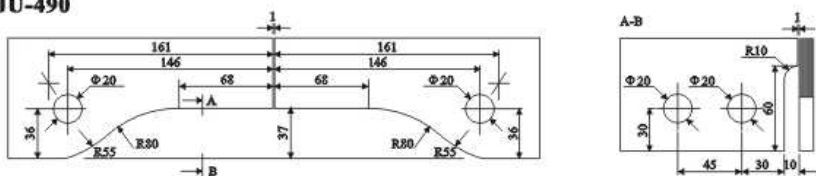
JU-010 JU-010b JU-020 JU-030 JU-410 JU-420

JU-480/R

• JU-480/L



• JU-490



• JU-040

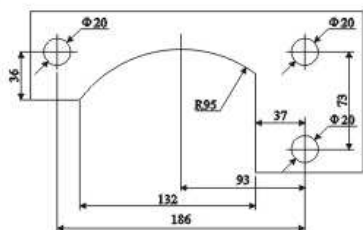

• JS-010 JS-510 JU-510b

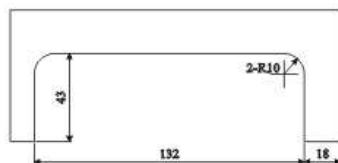

• JU-610b JU-450

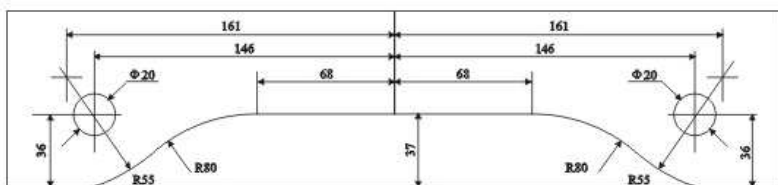

• JU-620b JU-630b

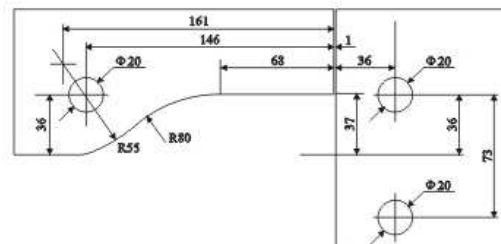

• JS-120

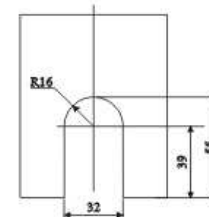

• JU-120b

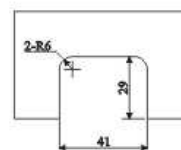

• JS-130 JU-130b

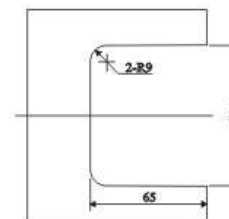

• JU-210b



• JU-220

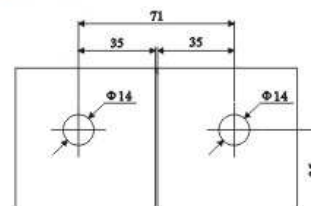

• JS-520

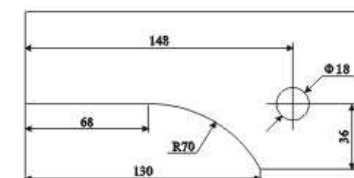

• JS-530

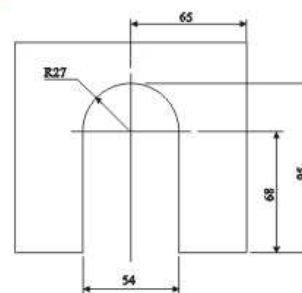

• JU-430 JU-460 JU-470

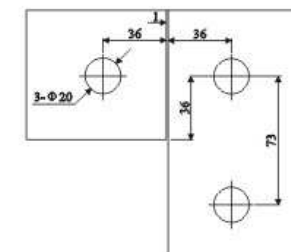

SERIES

JUSTOR PROFESSIONAL FLOOR HINGE

JUSTOR

专业型地弹簧系列

JUSTOR 专业型地弹簧系列

JUSTOR PROFESSIONAL FLOOR HINGE SERIES

选用优质铝合金型材为内芯，装饰外壳采用进口不锈钢板精密折边而成高度仅65mm；表面处理颜色：镜面、砂光、钛金或根据客户订做颜色。

Quality Aluminum alloy section is used as inner core, Decorative case is made of imported stainless steel sheet with precise edge fold in height of 65mm only. Color for surface treatment: mirror surface, polishing, Titanium-golden or other colors that customer requires.



JU-28A 地弹簧功能说明

THE FUNCTION INSTRUCTION OF JU-28A FLOOR HINGE



- 内置减压阀，防止因外来强压或强风状态下闭门而造成的地弹簧损坏或漏油。
- 通用型设计，适合左、右手及单双向开启门扇。
- 采用低温防冻液压油，保证在零下40度气温下不会影响闭门速度。
- 水泥盒中可调长度5mm、宽度5mm，在校准零位时可纵向调节±2°，使产品安装时更加方便。
- Inside pressure reducing valve: using to prevent the destruction of the floor spring or oil leakage on occasions that the door is closed by strong pressure or wind force.
- General design, suitable for left or right hand to open the door in single and both sides.
- Use low temperature frostbite hydraulic oil, ensuring the normal door-closing speed when the temperature is forty degree below zero degree.
- For cement container, 5mm adjustable in length and width, and 2 degree vertically adjustable when the calibration position is zero.

技术数据

Technological data

功能特性 Feature	技术参数 Technological data	选项 Choice
闭门力量 Closing force	15Nm 牛顿米	—
适合最大门宽 Suitable for maximum wide door leaf	≤1050mm	—
最大门重 The maximum bearing weight	80kg	—
闭门速度以调节阀控制 The door closed speed is controlled by the adjusting valve	—	●
定位 Opening angle	—	●
重量 Weight	约为5.5kg	—
底座尺寸 Container Size	长 Length	251mm
	宽 Width	101mm
	高 Height	50.5mm
通过国家QB/T3884-99标准检验 The products have passed national QB/T 3884-99 standard	—	●

● 有 — 无 ○ 可选
Yes No Choice

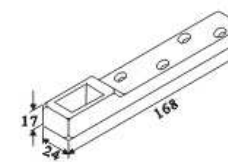
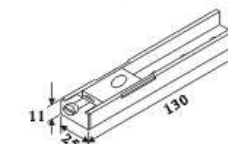
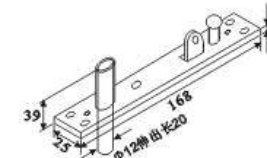
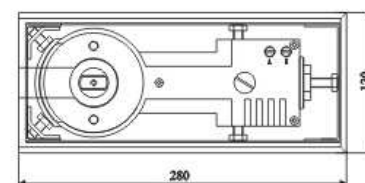
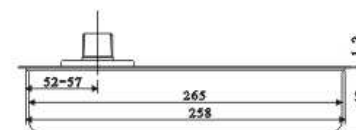
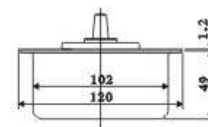
剖析图例说明

CUTAWAY VIEW INSTRUCTION



- 1、饰板固定螺丝
Plaque fastening screw
- 2、不锈钢饰板
Stainless plaque
- 3、防尘套
Dustproof cover
- 4、凸轮盖板
Bulge axle plaque
- 5、凸轮
Bulge axle
- 6、拖板
Supporting plate
- 7、定位滑轮
Orientated sheave
- 8、弹簧
Spring
- 9、连杆
Link

- 10、活塞
Piston
- 11、压力轴承
Pressure bearing
- 12、工艺塞 (注：只限制造商生产使用)
Technological valve
Remark: Only the manufacturer have the authorization to produce and use.
- 13、速度调节阀
Velocity regulating valve
- 14、横向调节螺丝
Horizontal regulating valve
- 15、纵向调节螺丝
Vertical regulating valve
- 16、尾塞
Rear valve
- 17、主机缸体
Main body container
- 18、水泥盒
Cement container

JU-28 地弹簧功能说明

THE FUNCTION INSTRUCTION OF JU-28 FLOOR HINGE



- ◆ 内置减压阀，防止因外来强压或强风状态下闭门而造成的地弹簧损坏或漏油。
- ◆ 通用型设计，适合左、右手及单双向开启门扇。
- ◆ 采用低温防冻液压油，保证在零下40度气温下不会影响闭门速度。
- ◆ 水泥盒中可调长度5mm、宽度5mm，在校准零位时可纵向调节±2°，使产品安装时更加方便。
- ◆ Inside pressure reducing valve: using to prevent the destruction of the floor spring or oil leakage on occasions that the door is closed by strong pressure or wind force.
- ◆ General design, suitable for left or right hand to open the door in single and both sides.
- ◆ Use low temperature frostbite hydraulic oil, ensuring the normal door-closing speed when the temperature is forty degree below zero degree.
- ◆ For cement container, 5mm adjustable in length and width, and 2 degree vertically adjustable when the calibration position is zero.

技术数据

Technological data

功能特性 Feature	技术参数 Technological data	选项 Choice
闭门力量 Closing force	15Nm 牛·厘米	—
适合最大门宽 Suitable for maximum wide door leaf	≤1050mm	—
最大门重 The maximum bearing weight	90kg	—
闭门速度以调节阀控制 The door closed speed is controlled by the adjusting valve	—	●
定位 Opening angle	90°	●
重量 Weight	约为5.5kg	—
底座尺寸 Container Size	长 Length	253mm
	宽 Width	103mm
	高 Height	52mm
通过国家QB/T3884-99标准检验 The products have passed national QB/T 3884-99 standard	—	●

● 有 — 无 ○ 可选
 Yes No Choice

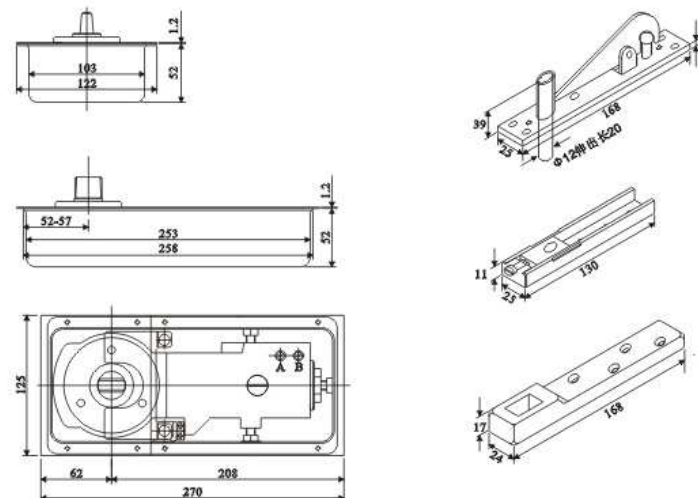
剖视图例说明

CUTAWAY VIEW INSTRUCTION



- | | |
|---|---|
| 1、饰板固定螺丝
Plaque fastening screw | 14、工艺塞 (注：只限制造商生产使用)
Technological valve
Remark: Only the manufacturer have the authorization to produce and use. |
| 2、不锈钢饰板
Stainless plaque | 15、速度调节阀
Velocity regulating valve |
| 3、压板固定螺丝
Fasteningscrew for bearing plaque | 16、横向调节螺丝
Horizontal regulating valve |
| 4、主机体压板
Main body bearing plaque | 17、纵向调节螺丝
Vertical regulating valve |
| 5、防尘套
Dustproof cover | 18、尾塞
Rear valve |
| 6、凸轮盖板
Bulge axle plaque | 19、主机缸体
Main body container |
| 7、凸轮
Bulge axle | 20、水泥盒
Cement container |
| 8、拖板
Supporting plate | |
| 9、定位滑轮
Orientated sheave | |
| 10、弹簧
Spring | |
| 11、连杆
Link | |
| 12、活塞
Piston | |
| 13、压力轴承
Pressure bearing | |

JU-30 地弹簧功能说明

THE FUNCTION INSTRUCTION OF JU-30 FLOOR HINGE



- 采用单缸设计, 开门力度更轻, 闭门速度更稳。使用寿命更长久。
- 内置减压阀, 防止因外来强压或强风状态下闭门而造成的地弹簧损坏或漏油。
- 通用型设计, 适合左、右手及单双向开启门扇。
- 采用低温防冻液压油, 保证在零下40度气温下不会影响闭门速度。
- 水泥盒中可调高度、宽度、长度, 使产品安装时更加方便。
- Adopting double-spring design, opening lightly and closing smoothly, prolonging service life.
- Inside pressure reducing valve: using to prevent the destruction of the floor spring or oil leakage on occasions that the door is closed by strong pressure or wind force.
- General design, suitable for left or right hand to open the door in single and both sides.
- Use low temperature frostbite hydraulic oil, ensuring the normal door-closing speed when the temperature is forty degree below zero degree.
- Cement container, height, width and length can be adjustable which is convient for assembling.

技术数据

Technological data

功能特性 Feature	技术参数 Technological data	选项 Choice
闭门力量 Closing force	25Nm 牛顿米	—
适合最大门宽 Suitable for maximum wide door leaf	≤ 1200mm	—
最大门重 The maximum bearing weight	110kg	—
闭门速度以调节控制 The door closed speed is controlled by the adjusting valve	—	●
定位 Opening angle	90°	●
重量 Weight	约为6kg	—
底座尺寸 Container Size	长 Length	290mm
	宽 Width	124mm
	高 Height	50mm
通过国家QB/T3884-99标准检验 The products have passed national QB/T 3884-99 standard	—	●

 ● 有 — 无 ○ 可选
Yes No Choice

线图

LINE FIGURE

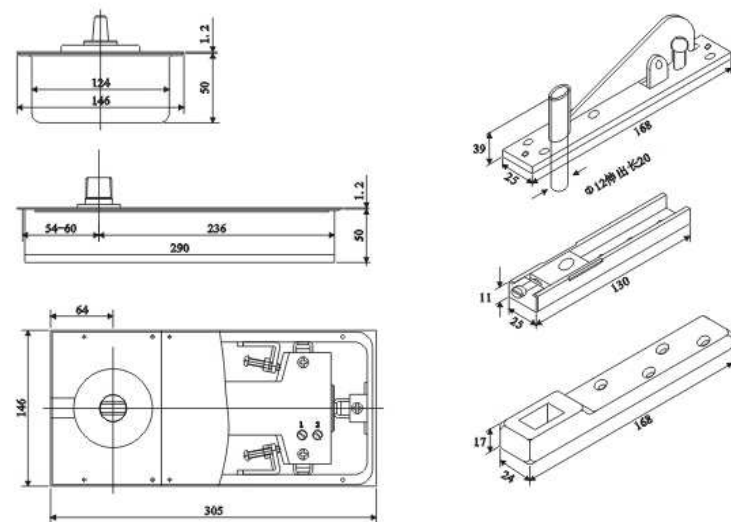

剖析图例说明

CUTAWAY VIEW INSTRUCTION



JU-48A 地弹簧功能说明

THE FUNCTION INSTRUCTION OF JU-48A FLOOR HINGE



- 内置减压阀，防止因外来强压或强风状态下闭门而造成的地弹簧损坏或漏油。
- 通用型设计，适合左、右手及单双向开启门扇。
- 采用低温防冻液压油，保证在零下40度气温下不会影响闭门速度。
- 水泥盒中可调长度6mm，在校准零位时可纵向调节±2°，使产品安装时更加方便。
- Inside pressure reducing valve: using to prevent the destruction of the floor spring or oil leakage on occasions that the door is closed by strong pressure or wind force.
- General design, suitable for left or right hand to open the door in single and both sides.
- Use low temperature frostbite hydraulic oil, ensuring the normal door-closing speed when the temperature is forty degree below zero degree.
- For cement container, 6mm adjustable in length and width, and 2 degree vertically adjustable when the calibration position is zero.

技术数据

Technological data

功能特性 Feature	技术参数 Technological data	选项 Choice
闭门力量 Closing force	25Nm 牛顿米	—
适合最大门宽 Suitable for maxdum wide door leaf	≤1200mm	—
最大门重 The maxdum bearing weight	120kg	—
闭门速度以调节阀控制 The door closed speed is controlled by the adjusting valve	—	●
定位 Opening angle	90°	●
重量 Weight	约为6kg	—
底座尺寸 Container Size	长 Length	290mm
	宽 Width	124mm
	高 Height	50mm
通过国家QB/T3884-99标准检验 The products have passed national QB/T 3884-99 standard	—	●

● 有 — 无 ○ 可选
Yes No Choice

线图

LINE FIGURE

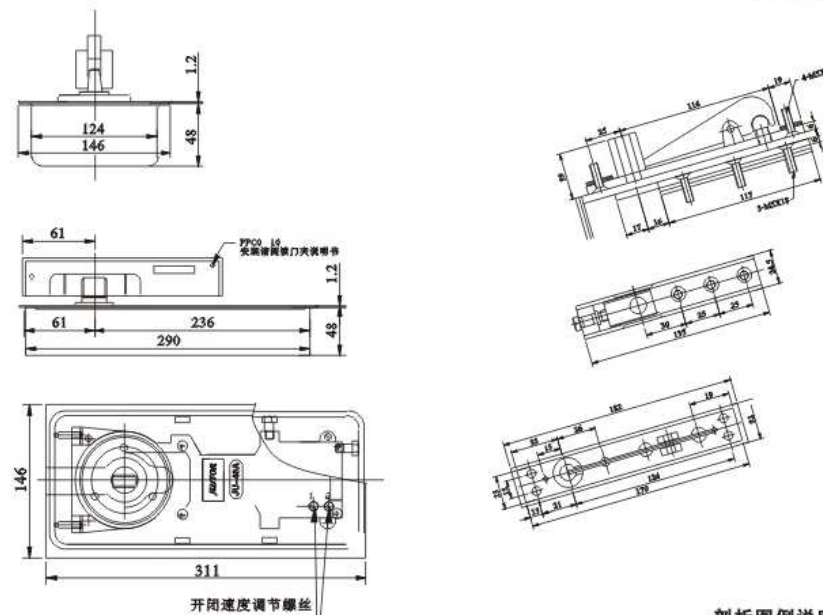
剖析图例说明

CUTAWAY VIEW INSTRUCTION



- | | |
|------------------------------------|--|
| 1、饰板固定螺丝
Plaque fastening screw | 10、活塞
Piston |
| 2、不锈钢饰板
Stainless plaque | 11、压力轴承
Pressure bearing |
| 3、防尘套
Dustproof cover | 12、速度调节阀
Velocity regulating valve |
| 4、凸轮盖板
Bulge axle plaque | 13、横向调节螺丝
Horizontal regulating valve |
| 5、凸轮
Bulge axle | 14、纵向调节螺丝
Vertical regulating valve |
| 6、拖板
Supporting plate | 15、水平调节螺丝
Horizontal regulating screw |
| 7、定位滑轮
Orientated sheave | 16、尾塞
Rear valve |
| 8、弹簧
Spring | 17、主机缸体
Main body container |
| 9、连杆
Link | 18、水泥盒
Cement container |

JU-65 地弹簧功能说明

THE FUNCTION INSTRUCTION OF JU-65 FLOOR HINGE



- 内置减压阀，防止因外来强压或强风状态下闭门而造成的地弹簧损坏或漏油。
- 通用型设计，适合左、右手及双向开启门扇。
- 采用低温防冻液压油，保证在零下40度气温下不会影响闭门速度。
- 水泥盒中可调长度6mm，在校准零位时可纵向调节±2°，使产品安装时更加方便。
- Inside pressure reducing valve: using to prevent the destruction of the floor spring or oil leakage on occasions that the door is closed by strong pressure or wind force.
- General design, suitable for left or right hand to open the door in single and both sides.
- Use low temperature frostbite hydraulic oil, ensuring the normal door-closing speed when the temperature is forty degree below zero degree.
- For cement container, 6mm adjustable in length and width, and 2 degree vertically adjustable when the calibration position is zero.

技术数据

Technological data

功能特性 Feature	技术参数 Technological data	选项 Choice
闭门力量 Closing force	25Nm 牛顿米	—
适合最大门宽 Suitable for maximum wide door leaf	≤1200mm	—
最大门重 The maximum bearing weight	120kg	—
闭门速度以调节阀控制 The door closed speed is controlled by the adjusting valve	—	●
定位 Opening angle	90°	●
重量 Weight	约为6kg	—
底座尺寸 Container Size	长 Length	290mm
	宽 Width	124mm
	高 Height	50mm
通过国家QB/T3884-99标准检验 The products have passed national QB/T 3884-99 standard	—	●

● 有 Yes — 无 No ○ 可选 Choice

线图

LINE FIGURE

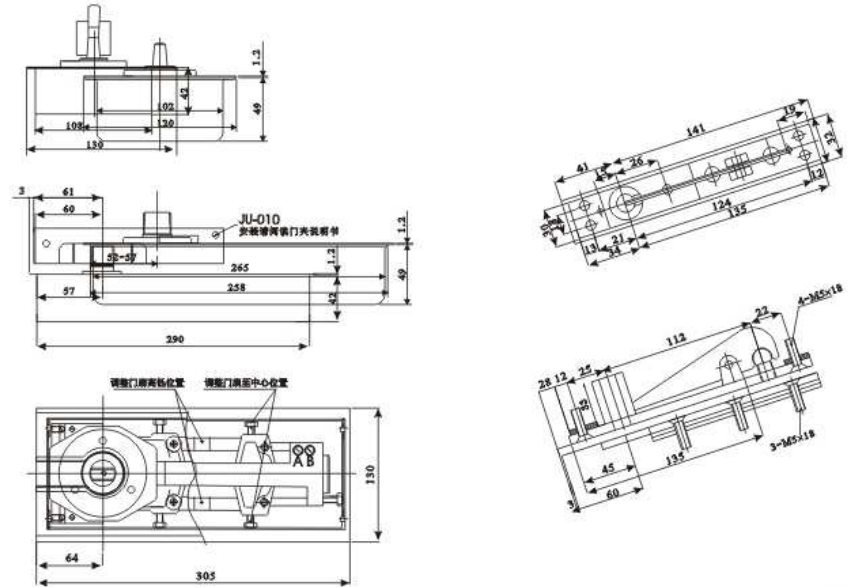
剖视图例说明

CUTAWAY VIEW INSTRUCTION



- | | |
|-------------------------------------|---|
| 1. 饰板固定螺丝
Plaque fastening screw | 10. 活塞
Piston |
| 2. 不锈钢饰板
Stainless plaque | 11. 压力轴承
Pressure bearing |
| 3. 防尘套
Dustproof cover | 12. 工艺阀 (注: 只限制造商生产使用)
Technological valve
Remark: Only the manufacturer have the authorization to produce and use. |
| 4. 凸轮盖板
Bulge axle plaque | 13. 速度调节阀
Velocity regulating valve |
| 5. 凸轮
Bulge axle | 14. 横向调节螺丝
Horizontal regulating valve |
| 6. 拖板
Supporting plate | 15. 纵向调节螺丝
Vertical regulating valve |
| 7. 定位滑轮
Orientated sheave | 16. 尾塞
Rear valve |
| 8. 弹簧
Spring | 17. 主机缸体
Main body container |
| 9. 连杆
Link | 18. 水泥盒
Cement container |

● JU-68A 地弹簧功能说明

THE FUNCTION INSTRUCTION OF JU-68A FLOOR HINGE



- 采用双缸设计, 开门力度更轻, 闭门速度更稳, 使用寿命更长久。
- 内置减压阀, 防止因外来强压或强风状态下闭门而造成的地弹簧损坏或漏油。
- 通用型设计, 适合左、右手及单双向开启门扇。
- 采用低温防冻液压油, 保证在零下40度气温下不会影响闭门速度。
- 水泥盒中可调高度6mm, 宽度5mm, 长度10mm, 使产品安装时更加方便。
- 超薄型设计, 在特殊要求地区安装使用更方便。
- Adopting double-spring design, opening lightly and closing smoothly, prolonging service life.
- Inside pressure reducing valve: using to prevent the destruction of the floor spring or oil leakage on occasions that the door is closed by strong pressure or wind force.
- General design, suitable for left or right hand to open the door in single and both sides.
- Use low temperature frostbite hydraulic oil, ensuring the normal door-closing speed when the temperature is forty degree below zero degree.
- For cement container, 6mm adjustable in length, 5mm in width and 10mm in length, which is convient for assembling.
- Super thin designed, enable it convenient to be installed in district with special demands.

● 技术数据

Technological data

功能特性 Feature	技术参数 Technological data	选项 Choice
闭门力量 Closing force	25Nm 牛·厘米	25
适合最大门宽 Suitable for maximum wide door leaf	≤ 1200mm	—
最大门重 The maximum bearing weight	130kg	—
闭门速度以调节阀控制 The door closed speed is controlled by the adjusting valve	—	●
定位 Opening angle	90°	●
重量 Weight	约为6.5kg	—
底座尺寸 Container Size	长 Length	308mm
	宽 Width	108mm
	高 Height	42mm
通过国家QB/T3884-99标准检验 The products have passed national QB/T 3884-99 standard	—	●

● 有 — 无 ○ 可选
Yes No Choice

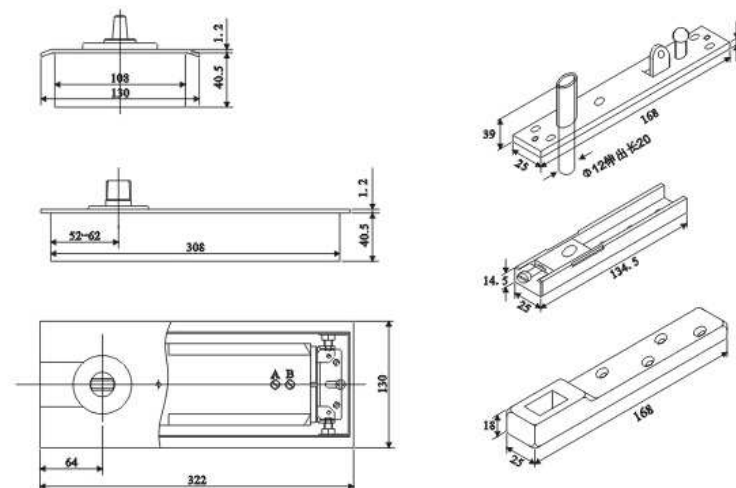

剖析图例说明

CUTAWAY VIEW INSTRUCTION



- | | |
|------------------------------------|--|
| 1、饰板固定螺丝
Plaque fastening screw | 12、活塞
Piston |
| 2、不锈钢饰板
Stainless plaque | 13、压力轴承
Pressure bearing |
| 3、防尘套
Dustproof cover | 14、速度调节阀
Velocity regulating valve |
| 4、凸轮盖板
Bulge axle plaque | 15、横向调节螺丝
Horizontal regulating valve |
| 5、凸轮
Bulge axle | 16、纵向调节螺丝
Vertical regulating valve |
| 6、拖板
Supporting plate | 17、水平调节螺丝
Horizontal regulating screw |
| 7、定位滑轮
Orientated sheave | 18、缸体固定架
Container fastening frame |
| 8、弹簧
Spring | 19、尾塞紧固螺丝
Rear valve fastening screw |
| 9、连杆
Link | 20、尾塞
Rear valve |
| 10、连杆紧固螺丝
Link Fastening Screw | 21、主机缸体
Main body container |
| 11、活塞销轴
Piston bolt | 22、水泥盒
Cement container |

● JU-80 地弹簧功能说明

THE FUNCTION INSTRUCTION OF JU-80 FLOOR HINGE



- 采用双缸设计, 开门力度更轻, 闭门速度更稳。使用寿命更长久。
- 内置减压阀, 防止因外来强压或强风状态下闭门而造成的地弹簧损坏或漏油。
- 通用型设计, 适合左、右手及单双向开启门扇。
- 采用低温防冻液压油, 保证在零下40度气温下不会影响闭门速度。
- 水泥盒中可调高度6mm, 宽度5mm, 长度10mm, 使产品安装时更加方便。
- 超薄型设计, 在特殊要求地区安装使用更方便。
- Adopting double-spring design, opening lightly and closing smoothly, prolonging service life.
- Inside pressure reducing valve: using to prevent the destruction of the floor spring or oil leakage on occasions that the door is closed by strong pressure or wind force.
- General design, suitable for left or right hand to open the door in single and both sides.
- Use low temperature frostbite hydraulic oil, ensuring the normal door-closing speed when the temperature is forty degree below zero degree.
- For cement container, 6mm adjustable in height, 5mm in width and 10mm in length, which is convient for assembling.
- Super thin designed, enable it convenient to be installed in district with special demands.

● 技术数据

Technological data

功能特性 Feature	技术参数 Technological data	选项 Choice
闭门力量 Closing force	35Nm 牛·厘米	—
适合最大门宽 Suitable for maximum wide door leaf	≤1500mm	—
最大门重 The maximum bearing weight	150kg	—
闭门速度以调节阀控制 The door closed speed is controlled by the adjusting valve	—	●
定位 Opening angle	90°	●
重量 Weight	约为6.5kg	—
底座尺寸 Container Size	长 Length	308mm
	宽 Width	108mm
	高 Height	42mm
通过国家QB/T3884-99标准检验 The products have passed national QB/T 3884-99 standard	—	●

● 有 一 无 ○ 可选
Yes No Choice

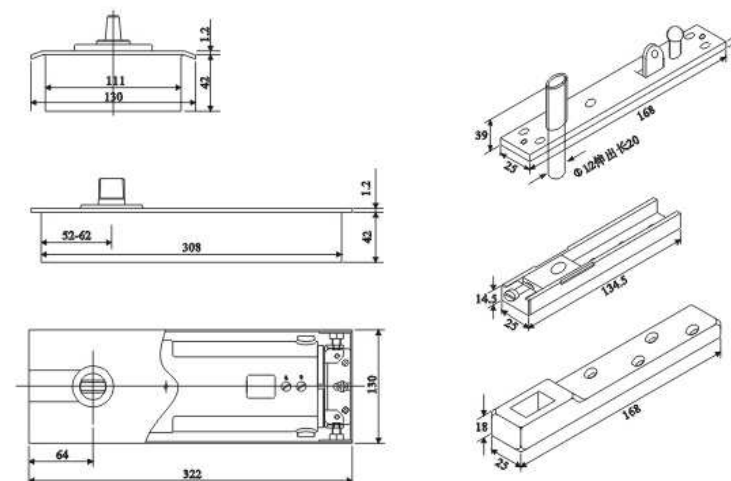

剖析图例说明

CUTAWAY VIEW INSTRUCTION



- | | |
|------------------------------------|--|
| 1、饰板固定螺丝
Plaque fastening screw | 12、活塞
Piston |
| 2、不锈钢饰板
Stainless plaque | 13、压力轴承
Pressure bearing |
| 3、防尘套
Dustproof cover | 14、速度调节阀
Velocity regulating valve |
| 4、凸轮盖板
Bulge axle plaque | 15、横向调节螺丝
Horizontal regulating valve |
| 5、凸轮
Bulge axle | 16、纵向调节螺丝
Vertical regulating valve |
| 6、拖板
Supporting plate | 17、水平调节螺丝
Horizontal regulating screw |
| 7、定位滑轮
Orientated sheave | 18、缸体固定架
Container fastening frame |
| 8、弹簧
Spring | 19、尾塞紧固螺丝
Rear valve fastening screw |
| 9、连杆
Link | 20、尾塞
Rear valve |
| 10、连杆紧固螺丝
Link Fastening Screw | 21、主机缸体
Main body container |
| 11、活塞插销
Piston bolt | 22、水泥盒
Cement container |

● JU-90 地弹簧功能说明

THE FUNCTION INSTRUCTION OF JU-90 FLOOR HINGE



- 采用单缸设计, 开门力度更轻, 闭门速度更稳。使用寿命更长久。
- 内置减压阀, 防止因外来强压或强风状态下闭门而造成的地弹簧损坏或漏油。
- 通用型设计, 适合左、右手及单双向开启门扇。
- 采用低温防冻液压油, 保证在零下40度气温下不会影响闭门速度。
- 水泥盒中可调高度、宽度、长度, 使产品安装时更加方便。
- Adopting double-spring design, opening lightly and closing smoothly, prolonging service life.
- Inside pressure reducing valve: using to prevent the destruction of the floor spring or oil leakage on occasions that the door is closed by strong pressure or wind force.
- General design, suitable for left or right hand to open the door in single and both sides.
- Use low temperature frostbite hydraulic oil, ensuring the normal door-closing speed when the temperature is forty degree below zero degree.
- For cement container, height, width and length can be adjusted which is convient for assembling.

● 技术数据

Technological data

功能特性 Feature	技术参数 Technological data	选项 Choice
闭门力量 Closing force	45Nm 牛·厘米	—
适合最大门宽 Suitable for maximum wide door leaf	≤1500mm	—
最大门重 The maximum bearing weight	180kg	—
闭门速度以调节阀控制 The door closed speed is controlled by the adjusting valve	—	●
定位 Opening angle	90°	●
重量 Weight	约为6.5kg	—
底座尺寸 Container Size	长 Length	278mm
	宽 Width	131mm
	高 Height	69.5mm
通过国家QB/T3884-99标准检验 The products have passed national QB/T 3884-99 standard	—	●

● 有 — 无 ○ 可选
Yes No Choice

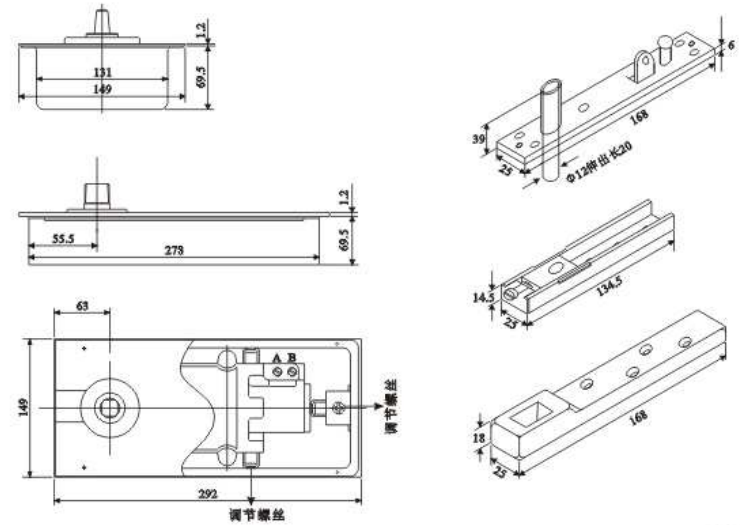

剖析图例说明

CUTAWAY VIEW INSTRUCTION



- | | |
|------------------------------------|--|
| 1、饰板固定螺丝
Plaque fastening screw | 10、活塞插销
Piston bolt |
| 2、不锈钢饰板
Stainless plaque | 11、速度调节阀
Velocity regulating screw |
| 3、防尘套
Dustproof cover | 12、压力轴承
Pressure bearing |
| 4、凸轮盖板
Bulge axle plaque | 13、横向调节螺丝
Horizontal regulating valve |
| 5、凸轮
Bulge axle | 14、水平调节螺丝
Horizontal regulating screw |
| 6、拖板
Supporting plate | 15、纵向调节螺丝
Vertical regulating screw |
| 7、定位滑轮
Orientated sheave | 16、尾塞
Rear valve |
| 8、弹簧
Spring | 17、主机缸体
Main body container |
| 9、连杆
Link | 18、水泥盒
Cement container |

闭门器
DOOR
Closer



• JU-082 • JU-051 • JU-071 • JU-072

DOOR CLOSER
2008-09 ▶▶



• JU-092 • JU-097

即施安牌系列闭门器是开达五金装饰有限公司生产的高档装饰五金配件一。产品适用于宾馆、写字楼、商场、家居、卫生间门、厨房门、通道门。

性能指标(及型号)

液压式闭门器

- 符合国家QB/T3893-99标准, (国)字, [C0455]号, 报告编号: A-01065a.
- 闭门速度二段无级调速, 适应不同需要。
- 有定位型在90±5以上可动定位, 满足环境特别需要。
- 无定位可在任意角度自动闭合, 适用于左右平开门。
- 闭门力度连续可调节, 闭门速度可调而且稳定性能好。
- 带液压式样闭锁功能特点, 适应不同环境需要。
- 标准颜色: K金\铬白\古铜或根据客户要求订做颜色。

弹力式闭门器

- 具五段速度调节, 可根据需求选用不同力度。

JUSTOR series door closer is one of the high-class decoration hardware accessories manufactured by KAIDA Hardware Decoration Limited Company, suitable for the doors of hotel, department store, household, toilet, and kitchen.

Performance Quota (andspecifications)

Hydraulic press door closer

- Accord with national QB/T3893-99 standard, No: A01065a.
- Two stage door closing speed adjustment, suitable for various demands.
- Closing at any degree, suitable for right or left opening door.
- Door closing dynamics can be constantly regulated. Door closing speed can be adjusted and well performed.
- Hydraulic press locking function, adapting in various environment.
- Standard color: K golden\chromium plating \copper plating or other kinds of color ou clients' requirements.

Spring door closer

- Five stage speed adjustment, choosing dynamics according to specific requirements.
- Standard color: K golden\chromium plating \copper plating or other kinds of color on clients' requirements.

技术参数

产品代号	最大门宽	适用门重
JU-051	800mm	15-30kg
JU-071	900mm	25-45kg
JU-072	1050mm	60-85kg
JU-082	900mm	25-45kg
JU-092	950mm	40-65kg
JU-097 (弹力式)	800mm	30kg以下

- 适用于最大门扇宽度为800mm的单向开启门, 最大门重为30kg。
- 精密油封, 防止漏油。
- 优质压铸铝合金机体, 以二层光亮漆保护。
- 两个液压阀独立控制两段闭门速度, 作180度全液压控制。
- 二段速度调节, 最大开启角度180度, 可订造90度-160度任意定位功能。
- 可直接安装在左右开启的门上, 无需任何改装。
- 标准颜色: 金色、银色、古铜色或根据要求订做颜色。
- Suitable for maximum 800mm wide door leaf of single direction opening door, the maximum door weight is 30kg .
- Precisely sealed, preventing oil leakage.
- High quality die-casting aluminum alloy, protected with two-layer bright paint.
- Two hydraulic press valves controlling two stage doors closing speed automatically, 180 degrees fully hydraulic control.
- Two stage speed adjustment, maximum opening degree is 180.90-160 degree locating function is available.
- Can be installed on right and left opening doors, with no need of refit.
- Standard color: golden, silver, copper or other kinds of color on clients' requirements.

● 技术数据

Technological data

功能特性 Feature	技术参数 Technological data	选项 Choice
闭门力级可调 Adjustable force of door closer	EN 1/2/3	—
门宽 Door width	≤800mm	●
向外开启之室外门 Outside door of opening outward	—	—
不分左右手 Indistinctive sides	—	●
摇臂类型 Types of rocking arm	标准摇臂 Standard rocking arm	●
	平滑摇臂 Smooth rocking arm	—
闭门速度可调 Speed adjustable door closer	180° -20°	●
闭锁速度可调 Speed adjustable lock	20° -0°	●
缓冲功能 Bufferfunction	—	—
延时功能 Delayfunction	—	—
定位功能 Orientingfunction	—	○
重量(kg) Weight	—	1.19
尺寸(mm) Size	长 Length	149mm
	宽 Width	37mm
	高 Height	56.7mm

● 是 — 否 ○ 可选
Yes No Choice

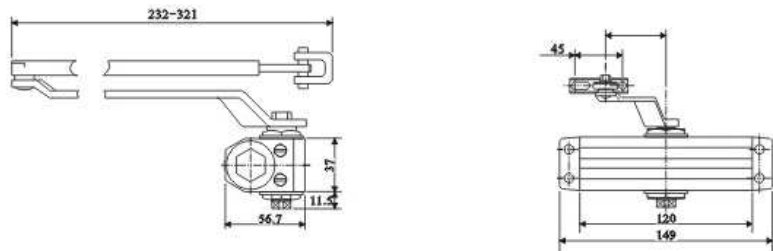

JU-051 闭门器
JU-051 DOOR CLOSER

尺寸
SIZE

标准安装

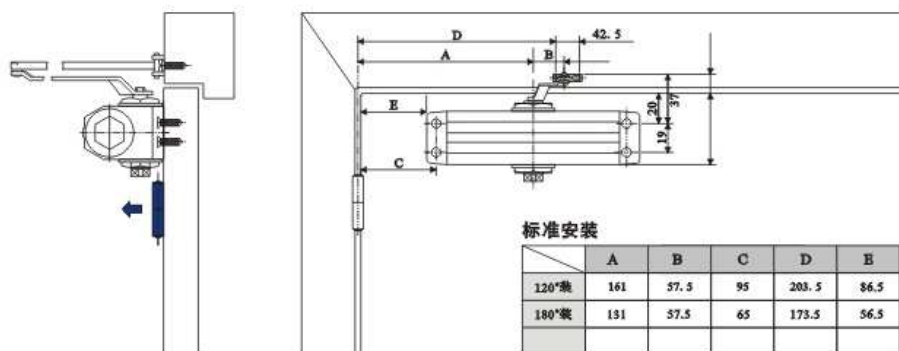
STANDARD INSTALL

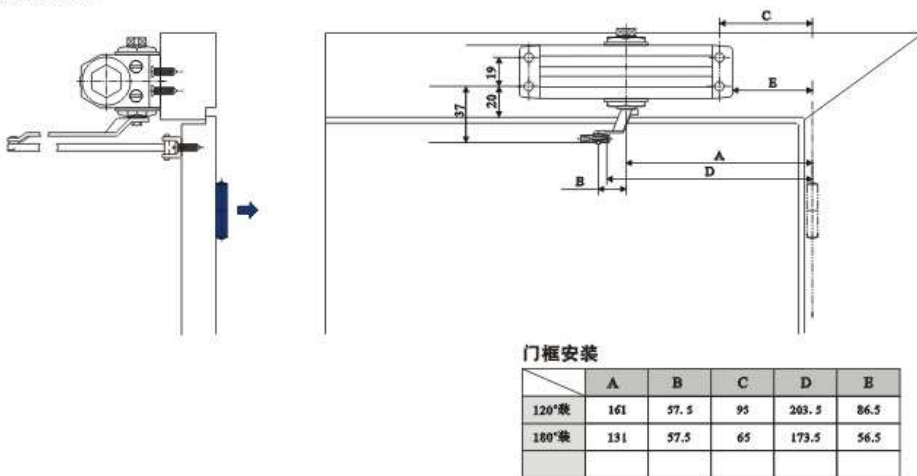

门框安装

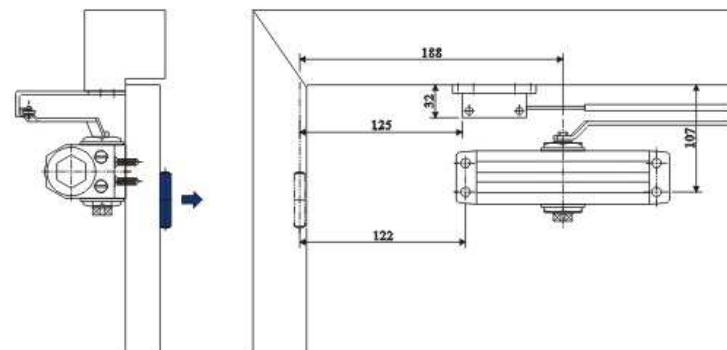
DOORCASE INSTALL

JU-051 闭门器
JU-051 DOOR CLOSER

平行摇臂座安装
PARALLEL ROCKING ARM PEDESTAL INSTALL

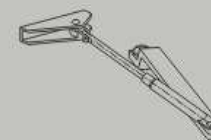
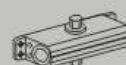
JU051闭门器
JU-051 Door Closer

圆管摇臂
Tube Rocking Arm

平行摇臂座
Parallel Rocking Arm Pedestal

规格1

= 闭门器+摇臂, 全套 # 选用配件

JU-071 闭门器
JU-071 DOOR CLOSER

- 标准型适用于最大扇宽度为900mm的单向开启门，最大门重为45kg。
 - 加重型适用于最大门扇宽度为950mm的单向开启门，最大门重为65kg
 - 精密油封，防止漏油。
 - 优质压铸铝合金机体，以二层光亮漆保护。
 - 两个液压阀独立控制两段闭门速度，作180度全液压控制。
 - 二段速度调节，可订造90度-160度任意定位功能。
 - 既可按常规方式安装在门板上，也可安装在门框上。
 - 标准颜色：金色、银色、古铜色或根据要求定做颜色。
- Suitable for maximum 900mm wide door leaf of single direction opening door, the maximum door weight 45 kg.
- Precisely sealed, preventing oil leakage.
- High quality die-casting aluminum alloy, protected with two-layer bright paint.
- Two hydraulic press valves controlling two stage doors closing speed automatically, 180 degrees fully hydraulic control.
- Two stage speed adjustment, 90-160 degree locating function is available.
- Either to be installed on doors with normal method or to be installed on door frame.
- Standard color: golden, silver, copper or other kinds of color on clients' requirements.



技术数据

Technological data

功能特性 Feature	技术参数 Technological data	选项 Choice
闭门力级可调 Adjustable force of door closer	EN 2/3/4	—
门宽 Door width	≤950mm	●
向外开启之室外门 Outside door of opening outward	—	—
不分左右手 Inclatinctive sides	—	●
摇臂类型 Types of rocking arm	标准摇臂 Standard rocking arm	●
	平滑摇臂 Smooth rocking arm	—
闭门速度可调 Speed adjustable door closer	180° -20°	●
闭锁速度可调 Speed adjustable lock	20° -0°	●
缓冲功能 Bufferfunction	—	—
延时功能 Delayfunction	—	—
定位功能 Orientingfunction	—	○
重量(kg) Weight	—	1.19
尺寸(mm) Size	长 Length	180mm
	宽 Width	43mm
	高 Height	65mm

 ● 是 — 否 ○ 可选
Yes No Choice

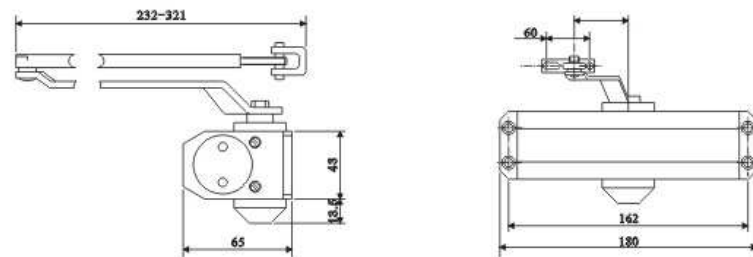
JU-071 闭门器
JU-071 DOOR CLOSER

 尺寸
SIZE

标准安装

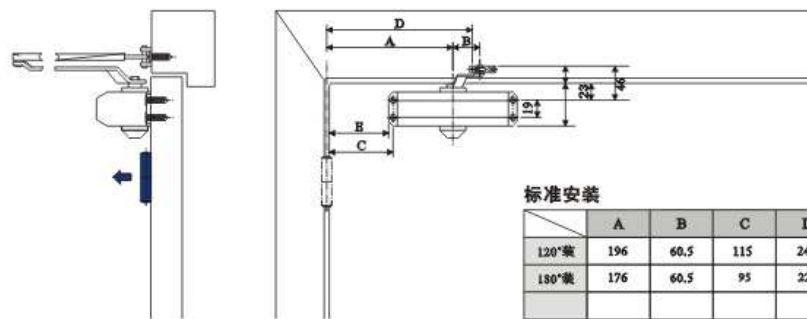
STANDARD INSTALL



标准安装

	A	B	C	D	E
120°装	196	60.5	115	240	106
180°装	176	60.5	95	220	86

门框安装

DOORCASE INSTALL

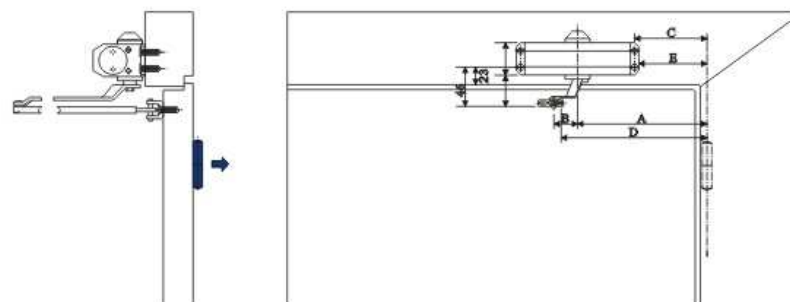

门框安装

	A	B	C	D	E
120°装	196	60.5	115	240	106
180°装	176	60.5	95	220	86

JU-071 闭门器

JU-071 DOOR CLOSER

平行摇臂座安装

PARALLEL ROCKING ARM PEDESTAL INSTALL

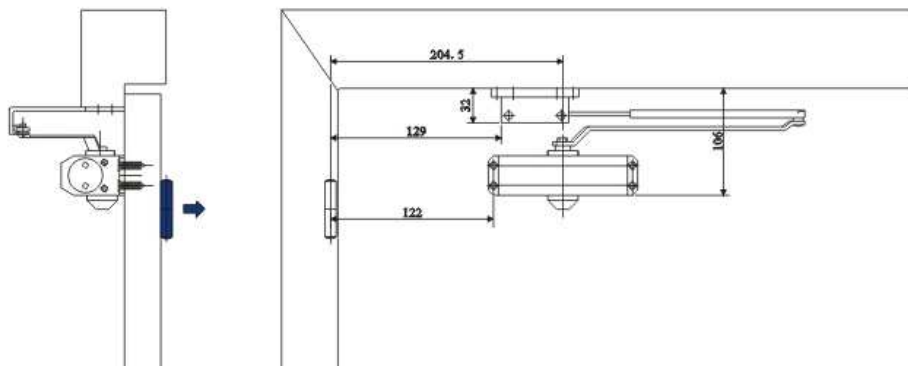

闭门力级选择

POWER LEVEL CHOICES

- JU071闭门力级可通过转换内部弹簧达到力量调整,以对应不同门扇宽度。
- Power level of JU071 can be adjusted through the regulation of

门宽 DOOR WIDTH	闭门力级 POWER LEVEL
≤900	2
≤950	3

JU071闭门器
JU-071 Door Closer

标准摇臂
Standard Rocking Arm

平行摇臂座
Parallel Rocking Arm Pedestal

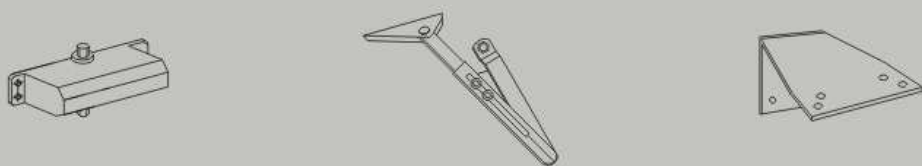

规格 2/3



#

■=闭门器+摇臂,全套 #=选用配件

JU-072 闭门器

JU-072 DOOR CLOSER

- 适用于最大门扇宽度为1050mm的单向开启门,最大门重为85kg。
- 精密油封,防止漏油。
- 优质压铸铝合金机体,以二层光亮漆保护。
- 两个液压阀独立控制两段闭门速度,作180度全液压控制。
- 二段速度调节。
- 既可按常规方式安装在门板上,也可安装在门框上。
- 标准颜色:金色、银色、古铜色或根据要求定做颜色。

- Suitable for maximum 1050mm wide door leaf of single direction opening door, the maximum door weight 85 kg.
- Precisely sealed, preventing oil leakage.
- High quality die-casting aluminum alloy, protected with two-layer bright paint.
- Two hydraulic press valves controlling two stage doors closing speed automatically, 180 degrees fully hydraulic control.
- Two stage speed adjustment.
- Either to be installed on doors with normal method or to be installed on door frame.
- Standard color: golden, silver, copper or other kinds of color on clients' requirements.



技术数据

Technological data

功能特性 Feature	技术参数 Technological data	选项 Choice
闭门力级可调 Adjustable force of door closer	EN 3/4/5	—
门宽 Door width	≤1050mm	●
向外开启之室外门 Outside door of opening outward	—	—
不分左右手 Indistinctive sides	—	●
摇臂类型 Types of rocking arm	标准摇臂 Standard rocking arm	●
	平滑摇臂 Smooth rocking arm	—
闭门速度可调 Speed adjustable door closer	180° -20°	●
闭锁速度可调 Speed adjustable lock	20° -0°	●
缓冲功能 Bufferfunction	—	—
延时功能 Delayfunction	—	—
定位功能 Orientingfunction	—	—
重量(kg) Weight	—	2.25
尺寸(mm) Size	长 Length	205mm
	宽 Width	48mm
	高 Height	71mm

●是 —否 ○可选
Yes No Choice

JU-072 闭门器
JU-072 DOOR CLOSER

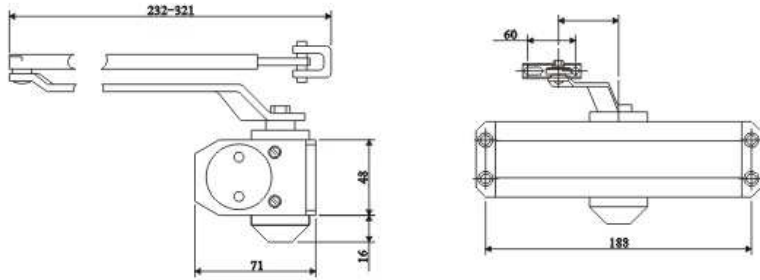
尺寸
SIZE

标准安装

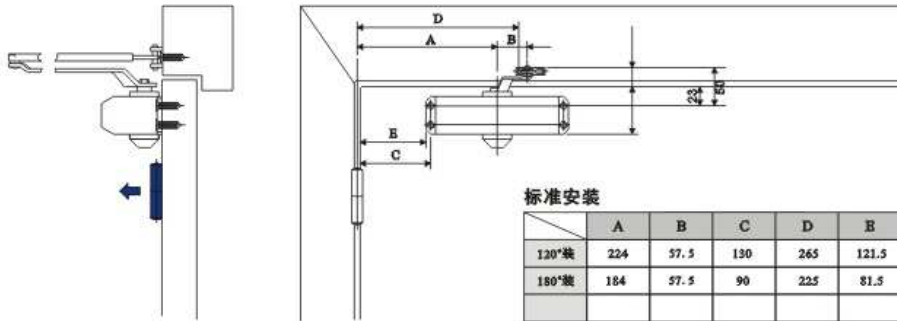
STANDARD INSTALL



标准安装

	A	B	C	D	E
120°装	224	57.5	130	265	121.5
180°装	184	57.5	90	225	81.5

门框安装

DOORCASE INSTALL

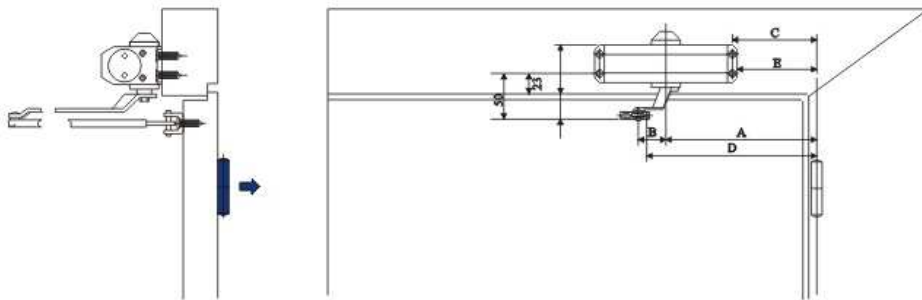

门框安装

	A	B	C	D	E
120°装	224	57.5	130	265	121.5
180°装	184	57.5	90	225	81.5

JU-072 闭门器
JU-072 DOOR CLOSER

平行摇臂座安装

PARALLEL ROCKING ARM PEDESTAL INSTALL

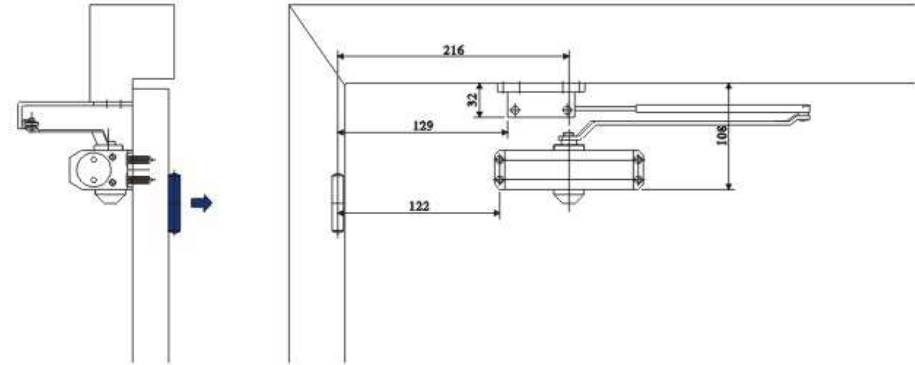
闭门力级选择

POWER LEVEL CHOICES

 JU072闭门器
JU-072 Door Closer

 标准摇臂
Standard Rocking Arm

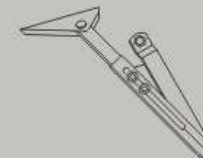
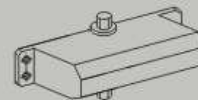
 平行摇臂座
Parallel Rocking Arm Pedestal

规格 4

- 标准行最大门扇宽度900mm的单向开启门，最大门重45kg。
- 加重型适用于最大门扇宽度为950mm的单向开启门，最大门重为65kg。
- 精密封油，防止漏油。
- 优质压铸铝合金机体用二层光亮漆保护。
- 两个液压阀独立控制两段闭门速度，作180度全液压控制。
- 二段速度调节，可订造90度-160度任意定位功能。
- 既可按常规方式安装在门上，也可安装在门框上。
- 标准颜色：金色、银色、古铜色或根据要求定做颜色。

- Can be used with single way opening door of 900mm's wide and 45kg in maximum.
- Keep the oil without leaking at all.
- Quality Aluminium-Alloy body is protected by two layer bright paint.
- Two hydraulic pressure valves control the speed of two section of door closer separately, wholly hydraulic pressure control in 180°.
- Two stage speed adjustment, 90-160 degree locating function is available.
- Can be installed in doors with regular measures, as well as in door frame.

技术数据

Technological data

功能特性 Feature	技术参数 Technological data	选项 Choice
闭门力级可调 Adjustable force of door closer	EN 2/3/4	—
门宽 Door width	≤950mm	●
向外开启之室外门 Outside door of opening outward	—	—
不分左右手 Indistinctive aides	—	●
摇臂类型 Types of rocking arm	标准摇臂 Standard rocking arm	●
	平滑摇臂 Smooth rocking arm	—
闭门速度可调 Speed adjustable door closer	180° -20°	●
闭锁速度可调 Speed adjustable lock	20° -0°	●
缓冲功能 Bufferfunction	—	—
延时功能 Delayfunction	—	—
定位功能 Orientingfunction	—	○
重量(kg) Weight	—	1.5
尺寸(mm) Size	长 Length	188mm
	宽 Width	47mm
	高 Height	38.5mm

● 是 Yes ○ 可选 Choice — 否 No

尺寸

SIZE

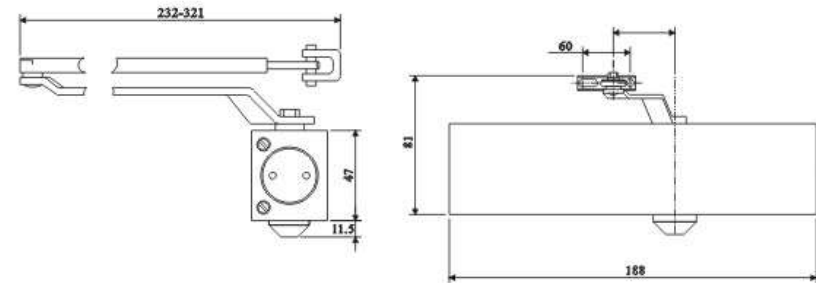
标准安装

STANDARD INSTALL

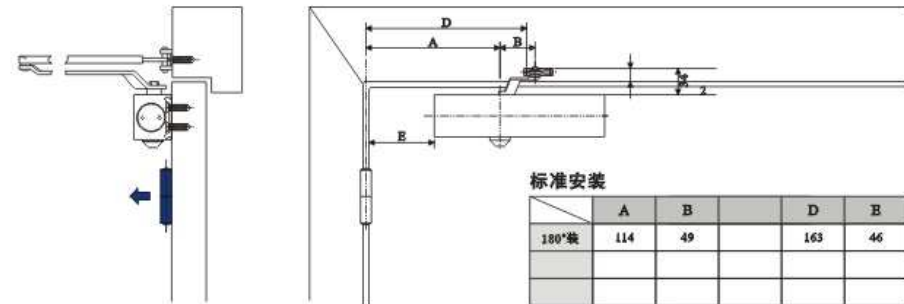
门框安装

DOORCASE INSTALL

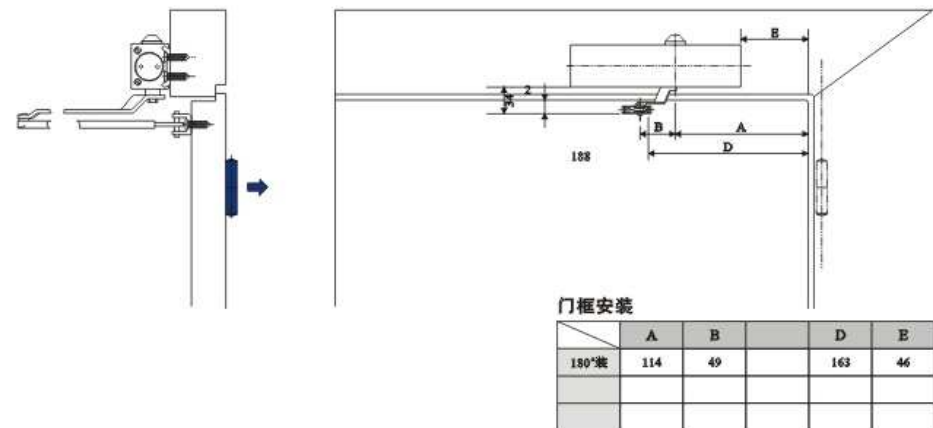

JU-082 闭门器

JU-082 DOOR CLOSER

平行摇臂座安装

PARALLEL ROCKING ARM PEDESTAL INSTALL

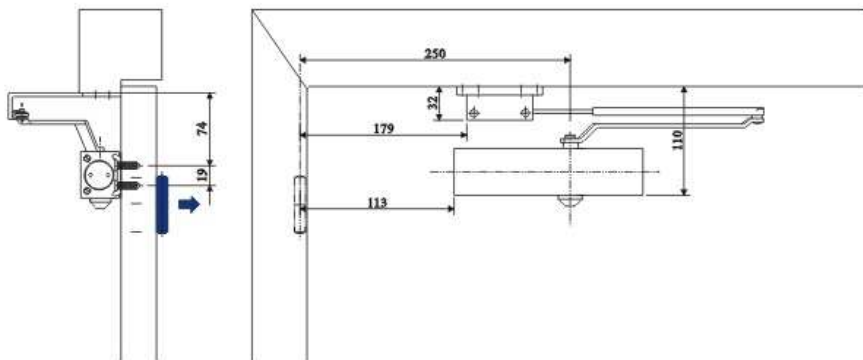
闭门力级选择

POWER LEVEL CHOICES

- Ju082闭门力级可通过转换内部弹簧达到力量调整。

- Power level of JU082 can be adjusted through the regulation of

门宽 DOOR WIDTH	闭门力级 POWER LEVEL
≤900	2
≤950	3

 JU082闭门器
JU-082 Door Closer

 标准摇臂
Standard Rocking Arm

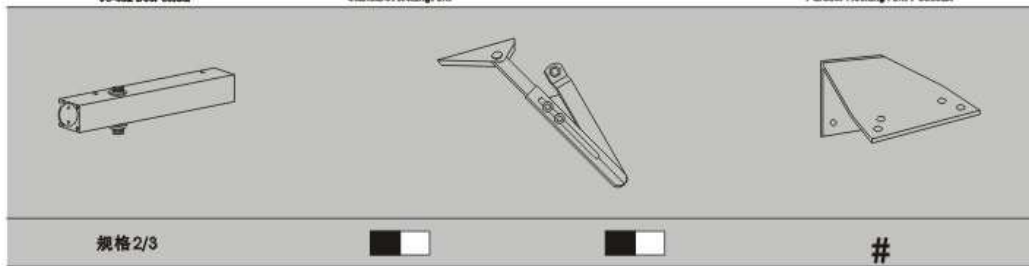
 平行摇臂座
Parallel Rocking Arm Pedestal

规格 2/3

#

■ = 闭门器+摇臂, 全套 # = 选用配件

- 适用于最大门扇宽度950mm的单向开启门, 最大门重65kg。
- 精密封油, 防止漏油。
- 优质压铸铝合金机体用二层光亮漆保护。
- 两个液压阀独立控制两段闭门速度, 作105度全液压控制。
- 二段速度调节, 可选用10度-105度任意定位功能。
- 既可按常规方式安装在门上, 也可安装在门框上。
- 标准颜色: 金色、银色、古铜色或根据要求定做颜色。

- Can be used with single way opening door of 950 mm's wide and 65 in maximum.
- Keep the oil without leaking at all.
- Quality Aluminium-Alloy body is protected by two layer bright paint.
- Two hydraulic pressure valves control the speed of two section of door closer separately, wholly hydraulic pressure control in 105°.
- Can be installed in doors with regular measures, as well as in door frame.
- Two stage speed adjustment, 10 - 105 degree locating function is available.
- Standard colors: golden, silver, bronze and other colors according to

技术数据

Technological data

功能特性 Feature	技术参数 Technological data	选项 Choice
闭门力级可调 Adjustable force of door closer	EN 2/3/4	—
门宽 Door width	≤950mm	●
向外开启之室外门 Outside door of opening outward	—	—
不分左右手 Indistinctive sides	—	●
摇臂类型 Types of rocking arm	标准摇臂 Standard rocking arm	●
	平滑摇臂 Smooth rocking arm	—
闭门速度可调 Speed adjustable door closer	105°-12'	●
闭锁速度可调 Speed adjustable lock	12-0'	●
缓冲功能 Buffer function	—	—
延时功能 Delay function	—	—
定位功能 Orienting function	—	○
重量 (kg) Weight	—	1.6
尺寸 (mm) Size	长 Length	230mm
	宽 Width	49mm
	高 Height	30mm

● 是 Yes — 否 No ○ 可选 Choice

JU-092 闭门器

JU-092 DOOR CLOSER

尺寸

SIZE

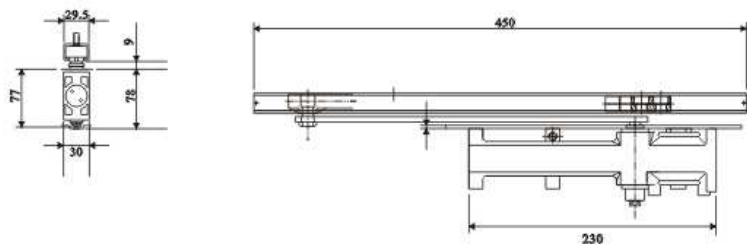

标准安装

STANDARD INSTALL

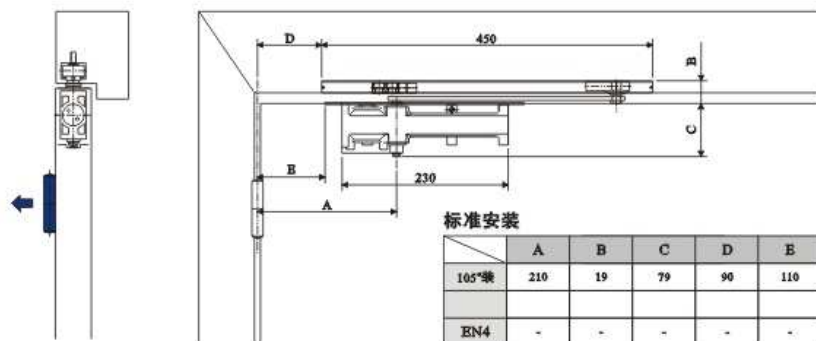

标准安装

	A	B	C	D	E
105° 装	210	19	79	90	110
EN4	-	-	-	-	-

门框安装

DOORCASE INSTALL

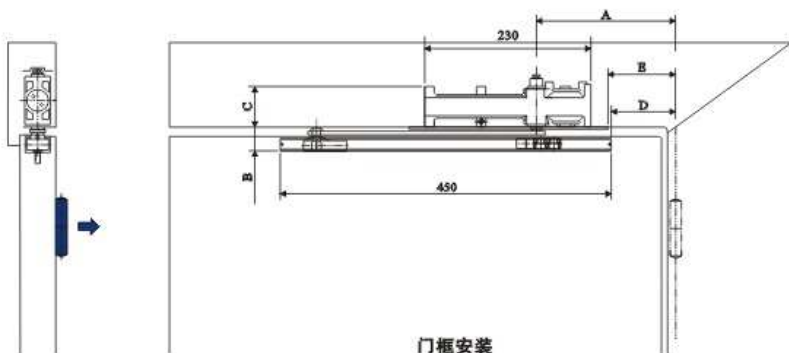

门框安装

	A	B	C	D	E
105° 装	210	19	79	90	110
	-	-	-	-	-

JU-092 闭门器

JU-092 DOOR CLOSER

闭门力级选择

POWER LEVEL CHOICES

JU092闭门器
JU-092 Door Closer

标准摇臂
Standard Rocking Arm

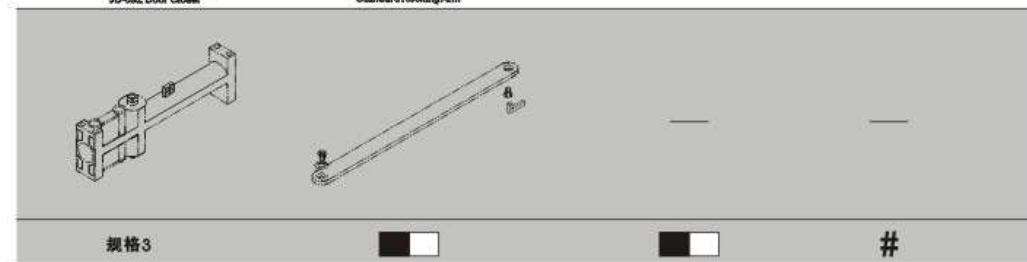

规格3 #
=闭门器+摇臂,全套 #=配件

JU-097 闭门器

JU-097 DOOR CLOSER

- 适用于最大门扇宽度为800mm的单向开启门，最大门重为30kg。
- 五段速度调节，可根据要求选用不同力度。
- 适用于左开和右开门，和适用于家庭房间门和酒店、宾馆卫生间门。
- 标准颜色：K金、铬白、古铜色、银灰、黑镍或根据要求定做颜色。
- Suitable 800mm maximum wide door leaf of single direction opening doors, maximum door weight is 30 kg.
- Five stage speed adjustment, different dynamics are available for selection.
- Suitable for right and left opening doors, household doors, hotel doors and toilet doors.
- Standard color: golden, silver, copper or other kinds of color on clients' requirements.

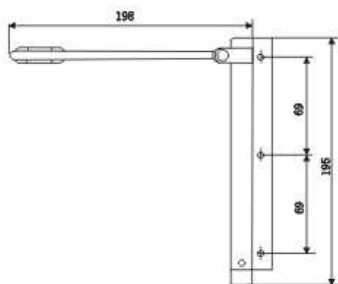

标准安装

STANDARD INSTALL

- 本产品安装在木门框或铝合金框上，安装位置应安装在门框的中间，用螺丝固定即可使用。
- The products can be installed on wooden or aluminum alloy door frame. The installation position should be in the middle of the door frame, and fasten with screw.

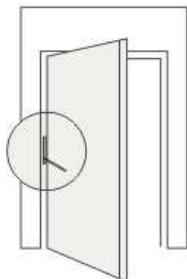
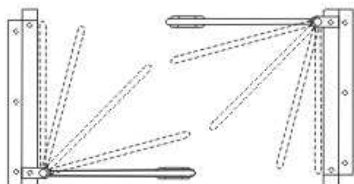

JU-097 闭门器

JU-097 DOOR CLOSER

调节方法

ADJUSTING METHOD

- 用配套内六角匙固定顶部内六角螺丝，再根据所需门的重量，在五个调节孔中选择所需力度。
- Firstly install the hexagonal screw and then adjust the dynamics of five adjusting holes in light of the door weight.

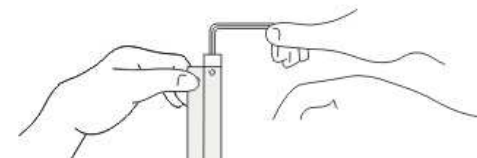

功能选择

FUNCTION SELECTION

- 本产品可在不需要使用时，将支臂收起即可，本产品亦可安装在左右门上。
- When the product is not in use, just fold its supporting arm. The product can also be installed on right and left opening doors.

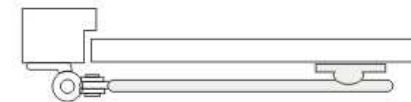

Bath

glass door locks

中央锁系列

Series



中央锁系列

● JU-W401



材质使用不锈钢压铸而成，配不锈钢夹，结构美观大方，防盗性强。
适用厚度为10-12mm的钢化玻璃门使用。
表面处理颜色：镜面、拉丝。

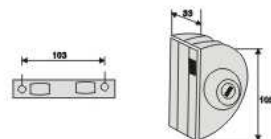

● JU-W404



材质使用不锈钢压铸而成，配不锈钢夹，结构美观大方，防盗性强。
适用厚度为10-12mm的钢化玻璃门使用。
表面处理颜色：镜面、拉丝。

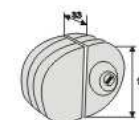

● JU-W402



材质使用不锈钢压铸而成，配不锈钢夹，结构美观大方，防盗性强。
适用厚度为10-12mm的钢化玻璃门使用。
表面处理颜色：镜面、拉丝。

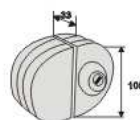

● JU-W405



材质使用不锈钢压铸而成，配不锈钢夹，结构美观大方，防盗性强。
适用厚度为10-12mm的钢化玻璃门使用。
表面处理颜色：镜面、拉丝。

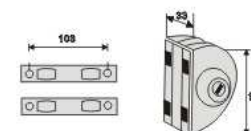

● JU-W403



材质使用不锈钢压铸而成，配不锈钢夹，结构美观大方，防盗性强。
适用厚度为10-12mm的钢化玻璃门使用。
表面处理颜色：镜面、拉丝。

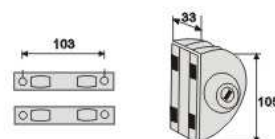

● JU-W406



材质使用不锈钢压铸而成，配不锈钢夹，结构美观大方，防盗性强。
适用厚度为10-12mm的钢化玻璃门使用。
表面处理颜色：镜面、拉丝。

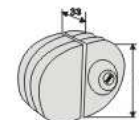

中央锁系列

● JU-W407



材质使用不锈钢压铸而成，配不锈钢夹，结构美观大方，防盗性强。
适用厚度为10-12mm的钢化玻璃门使用。
表面处理颜色：镜面、拉丝。

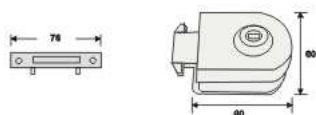

● JU-W408



材质使用不锈钢压铸而成，配不锈钢夹，结构美观大方，防盗性强。
适用厚度为10-12mm的钢化玻璃门使用。
表面处理颜色：镜面、拉丝。

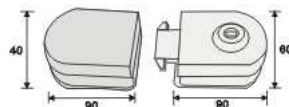

● JU-W409



材质使用不锈钢压铸而成，配不锈钢夹，结构美观大方，防盗性强。
适用厚度为10-12mm的钢化玻璃门使用。
表面处理颜色：镜面、拉丝。

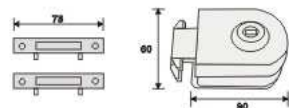

材质使用不锈钢压铸而成，配不锈钢夹，结构美观大方，防盗性强。
适用厚度为10-12mm的钢化玻璃门使用。
表面处理颜色：镜面、拉丝。

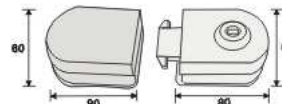

● JU-W410



材质使用不锈钢压铸而成，配不锈钢夹，结构美观大方，防盗性强。
适用厚度为10-12mm的钢化玻璃门使用。
表面处理颜色：镜面、拉丝。

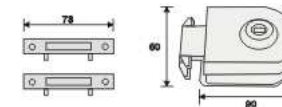

● JU-W411



材质使用不锈钢压铸而成，配不锈钢夹，结构美观大方，防盗性强。
适用厚度为10-12mm的钢化玻璃门使用。
表面处理颜色：镜面、拉丝。

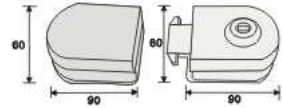

● JU-W412



Glass clip

浴室夹系列

Series



浴室夹系列

● JU-W101



90° 浴室玻璃，适用于宽800-1200mm，厚度8-12 mm安装，门关至35° 时，门会自动关闭。
表面处理颜色：镜光、砂光。承重：50kg
建议：用双层胶夹玻璃

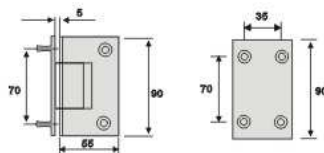

● JU-W104



90° 浴室玻璃，适用于宽800-1200mm，厚度8-12 mm安装，门关至35° 时，门会自动关闭。
表面处理颜色：镜光、砂光。承重：50kg
建议：用双层胶夹玻璃

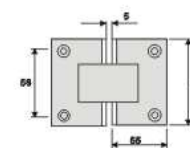

● JU-W102



90° 浴室玻璃，适用于宽800-1200mm，厚度8-12 mm安装，门关至35° 时，门会自动关闭。
表面处理颜色：镜光、砂光。承重：50kg
建议：用双层胶夹玻璃

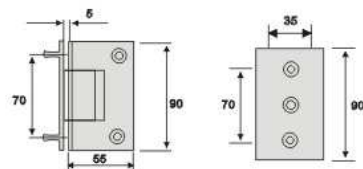

● JU-W105



90° 浴室玻璃，适用于宽800-1200mm，厚度8-12 mm安装，门关至35° 时，门会自动关闭。
表面处理颜色：镜光、砂光。承重：50kg
建议：用双层胶夹玻璃

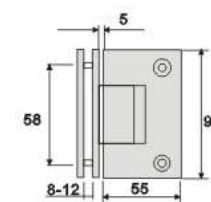

● JU-W103



90° 浴室玻璃，适用于宽800-1200mm，厚度8-12 mm安装，门关至35° 时，门会自动关闭。
表面处理颜色：镜光、砂光。承重：50kg
建议：用双层胶夹玻璃

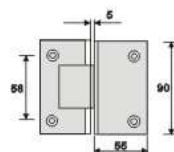

● 浴室夹系列

● JU-W106



90°浴室玻璃，适用于宽800-1200mm，厚度8-12mm安装，门关至35°时，门会自动关闭。
表面处理颜色：镜光、砂光，承重：50kg
建议：用双层胶夹玻璃

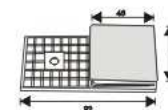

● JU-W109



● JU-W107

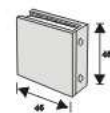

● JU-W110

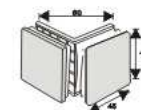

● JU-W108

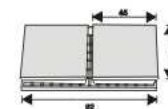
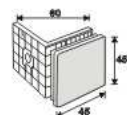

● JU-W111



HANDLES SERIES

拉手系列

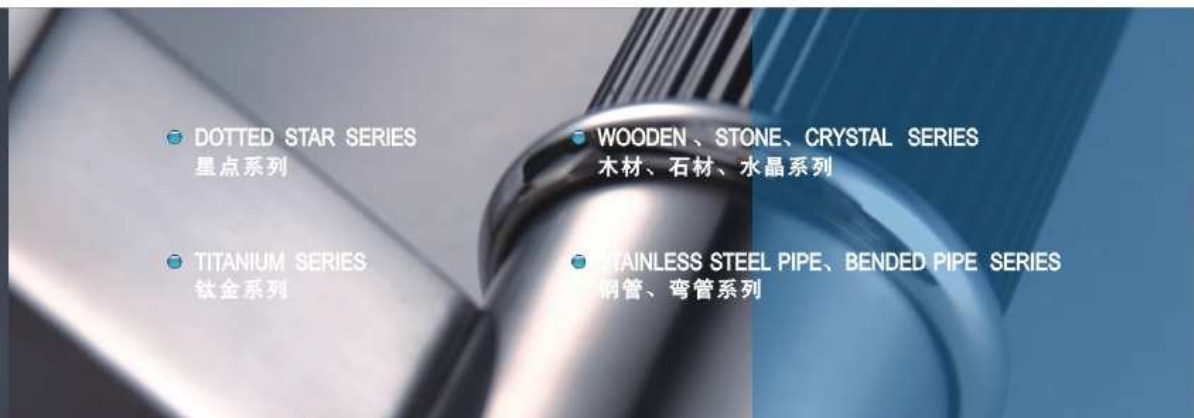
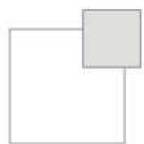

● DOTTED STAR SERIES
星点系列

● TITANIUM SERIES
钛金系列

● WOODEN、STONE、CRYSTAL SERIES
木材、石材、水晶系列

● STAINLESS STEEL PIPE、BENDED PIPE SERIES
钢管、弯管系列

PROFESSIONAL GLASS FITTINGS SERIES

玻璃门连接件系列



世界著名的JUSTOR即施妥专业玻璃连接系统，以其先进的技术和创新方式达到更有效利用光线，更快捷的施工效率、更环保的材料使用、同时给设计师保留了必要的设计创作空间。

各系列连件产品均具有完美的系统结构设计，能大大节省安装辅料、施工工期和费用，我们协同设计师一起研究玻璃结构运用方案，完善我们的产品，使之与整体建筑融为一体，也正是与设计师的这种紧密合作，我们推出了一系列的应用方案。

With the advanced technology and innovate mode, the world famous "JUSTOR" professional glass connecting system can make use of the rays more effectively, construct faster, adopt the material for environment protection and provide the designer with essential space for design and invention.

Each series of connecting product have perfect systemic structure design, which can save installation material, installation charge and shorten the construction period. We study the project of glass structure with designers to consummate our product and unify the product with the building. Just about the close cooperation with the designers, we recommend a series of application products.

● 每款产品均有两种连接玻璃的方式：斜口与直口。本公司生产的为斜口，可订做直口。
 Every product has two modes of connecting glass: vertical and fastigate. We can do it depends on order.

● 可供订做材质：
 Materials for ordering: 钛金 titanium 镜面 mirror 拉丝 satin

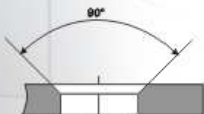

斜口连接方式
 Vertical connecting type

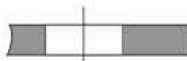

直口连接方式
 Fastigate connecting type

● 安装示例
 INSTALLING

● 安装示例A
 INSTALLING A

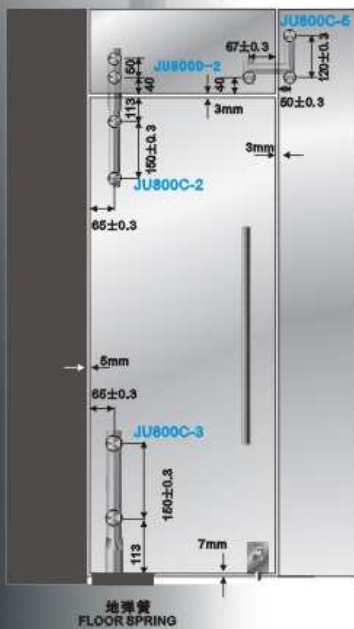

● 安装示例B
 INSTALLING B

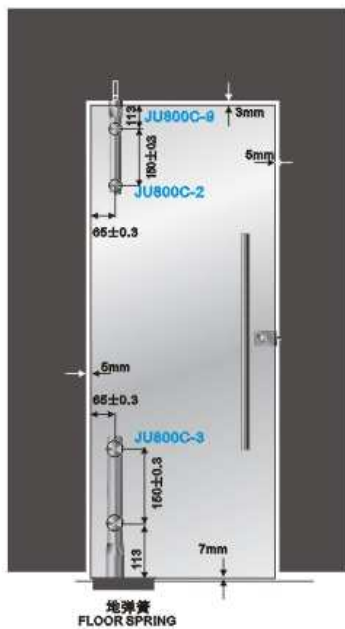

● 安装示例C
 INSTALLING C

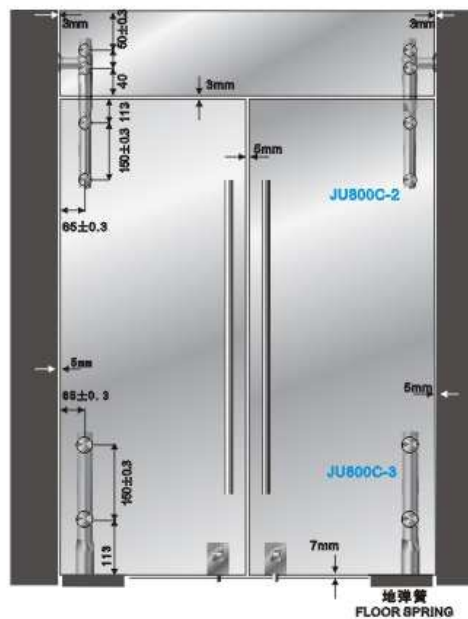

● 安装示例D
 INSTALLING D

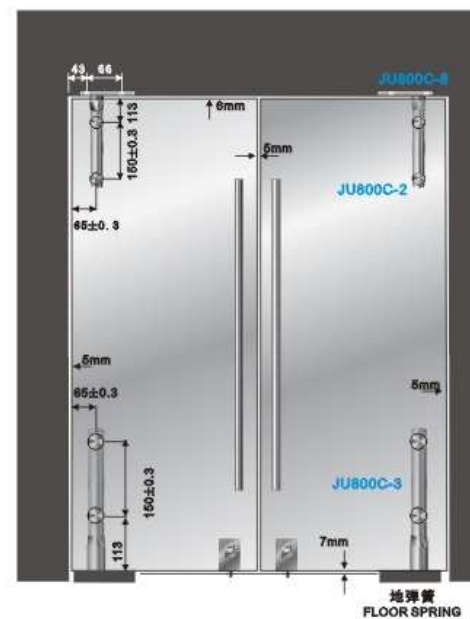

● 安装示例E
 INSTALLING E

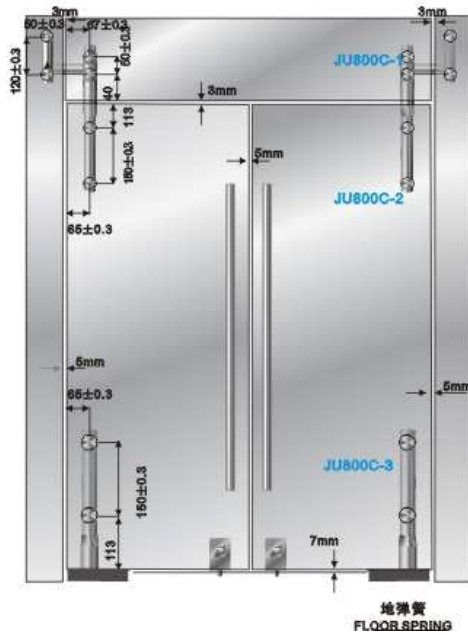

● 安装示例F
 INSTALLING F

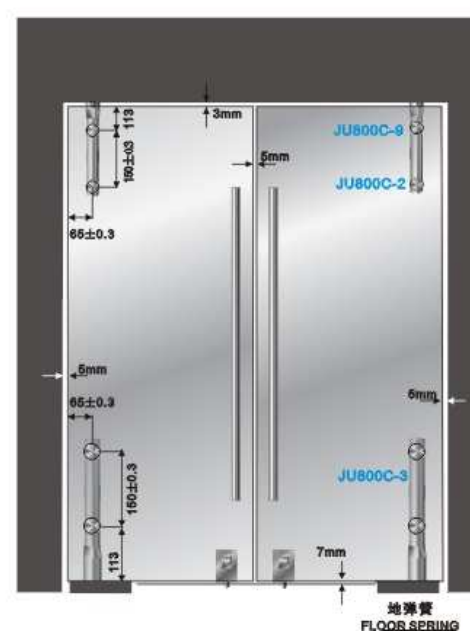

即施妥玻璃连接件系列

JUSTOR PROFESSIONAL GLASS FITTINGS SERIES

● 分别有两种连接玻璃的连接帽可供顾客选择, 主要是用于玻璃连接。
 Two kinds options of glass connection ,mainly used for clamping glass.

● 可供订做材质: 钛金 镜面 拉丝
 Materias fo ordering: titanium Mirror satin

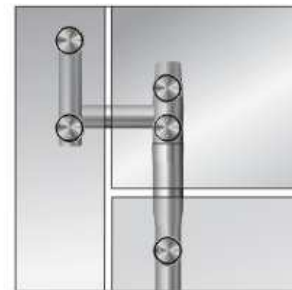

● JU800C-1
 曲型顶轴
 Overpanel/sidelight connector
 with pivot bearing location

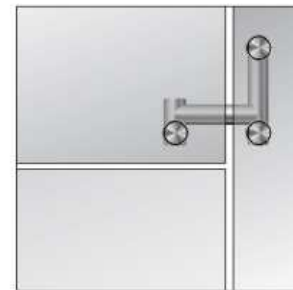

● JU800C-5
 曲型固定件
 Overpanel/sidelight
 connector

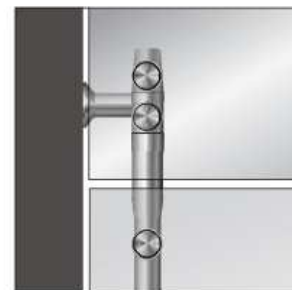

● JU800C-6
 T型顶轴
 T-type overpanel



● JU800C-7
 地轴
 Floor Pivot



● JU800C-8
 顶轴
 Upper-wall pivot



● JU800C-9
 顶轴
 Upper-wall pivot

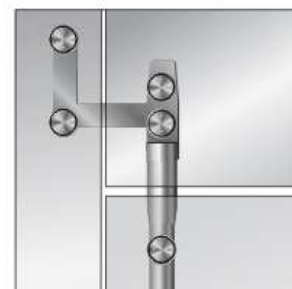

● JU800D-1
 曲型顶轴
 Overpanel/sidelight connector
 with pivot bearing location



● JU800D-2
 直顶轴
 Pivot Bearing Location
 For Overpanel

● 分别有两种连接玻璃的连接帽可供顾客选择, 主要是用于玻璃连接。
 Two kinds options of glass connection ,mainly used for clamping glass.

● 可供订做材质: 钛金 镜面 拉丝
 Materias fo ordering: titanium Mirror satin



● JU800C-2
 上轴
 Pivot pole with single point
 fixings and pivot bearing



● JU800C-3
 下轴
 Pivot pole with single point
 fixings and pivot bearing for
 floor pivot
 可提供各类型地弹簧接头
 Can offer kinds of floor spring
 connections



● JU800C-4
 连体轴
 Pivot pole with single point fixings and pivot bearing for
 intermediate tube
 可提供各类型地弹簧接头
 Can offer kinds of floor spring
 connections

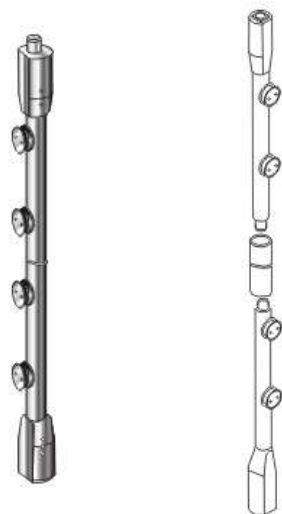

● 常规适合于最大玻璃重量100kg, 可订造适合最大厚度19mm, 最大重量150kg玻璃。
 Suitable for the glass maximum weight 100kg, but can order maximum thickness 19mm, maximum glass weight 150kg.

● 分别有两种连接玻璃的连接帽可供顾客选择，主要是用于玻璃连接。
Two kinds options of glass connection mainly used for clamping glass.

● 可供订做材质：钛金 镜面 拉丝
Material for ordering: titanium mirror satin

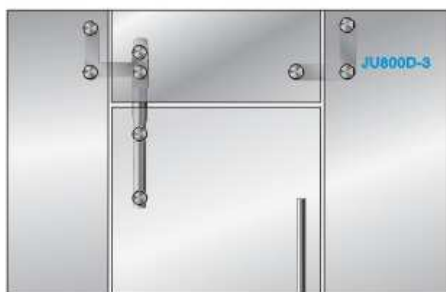

● JU800D-3
曲型固定件
Overpanel/sidelight connector

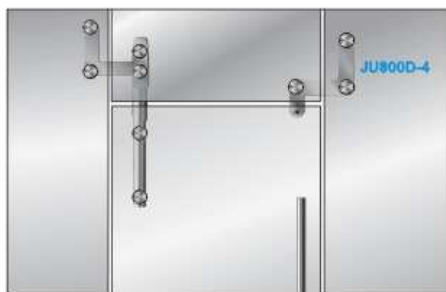

● JU800D-4
曲型固定件
Overpanel/sidelight connector
(带限位器)
Overpanel/sidelight connector with stop inside



● JU800D-5
限位器-5
Stop for overpanel mounting

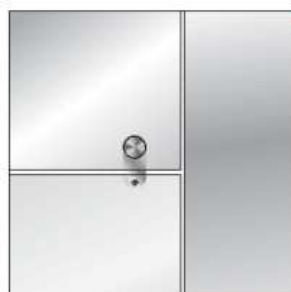
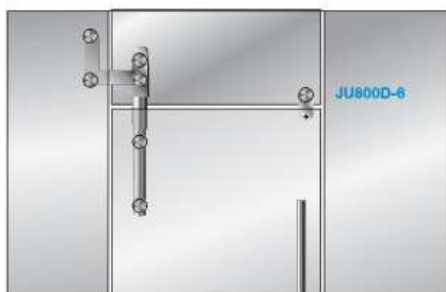

● JU800D-6
限位器-6
Stop for overpanel mounting



● 安装示例G INSTALLING G

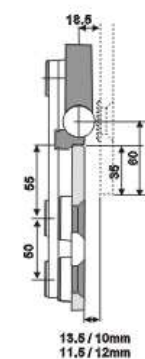

(根据门实际宽度确定尺寸，尺寸≥65MM)
(as required by installation, size ≥ 65MM)

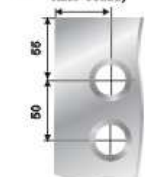

OW = overpanel width
SW = sidelight width
DW = door width

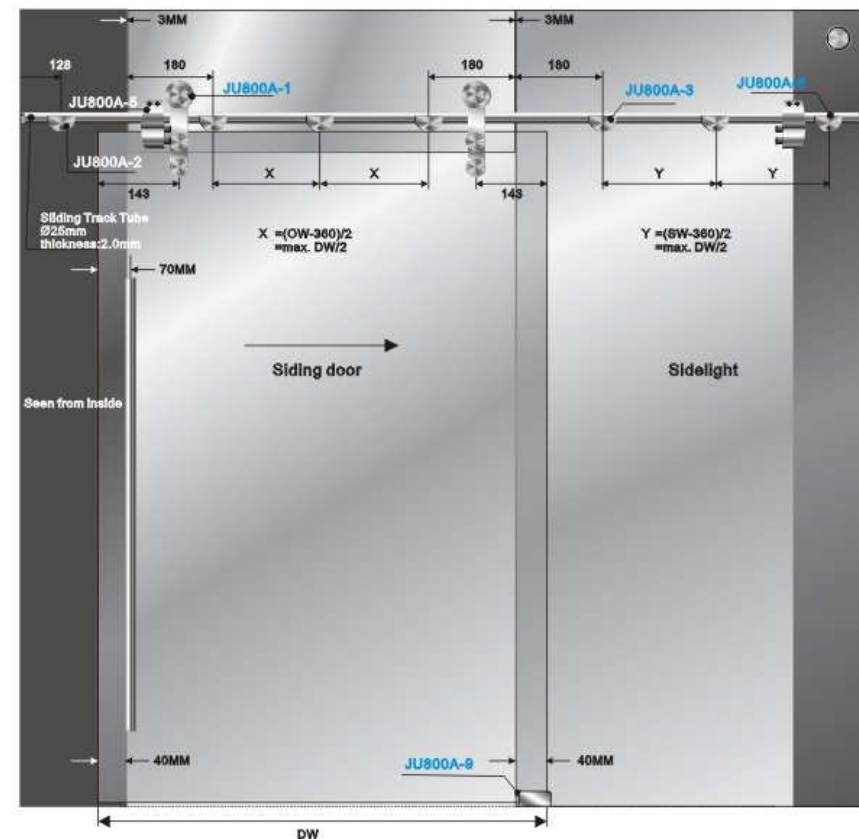

● 技术数据

Technological data

门移动长度 Daylight opening	入口宽 Entry width	门宽 Door width	管长 Tube length
910-1010mm	800-900mm	880-980mm	2038mm
1010-1110mm	900-1000mm	980-1080mm	2238mm
1110-1210mm	1000-1100mm	1080-1180mm	2438mm
1210-1310mm	1100-1200mm	1180-1280mm	2638mm

● 管夹的安装位置：

80Kg以下：按门实际宽度的1/2位置；
80Kg-120Kg：按门实际宽度的1/3位置；
120Kg-150Kg：按门实际宽度的1/4位置。

● The distance for clamp fixing for track, wall fixing:

1. Weight 80kg: max-distance between the clamps=1/2 the width of the door;
2. Weight 80kg-120kg: max-distance between the clamps=1/3 the width of the door;
3. Weight 120kg-150kg: max-distance between the clamps=1/4 the width of the door.



即施妥玻璃连接件系列

JUSTOR PROFESSIONAL GLASS FITTINGS SERIES

● 分别有两种连接玻璃的连接帽可供顾客选择, 主要用于玻璃连接。
Two kinds options of glass connection, mainly used for clamping glass.

● 可供订做材质: 钛金 镜面 拉丝
Materials for ordering: titanium mirror satin



● JU800A-1
玻璃吊轮
Sliding door roller



JU800A-1B
(最大玻璃承重150KG)
The glass maximum weight 150kg



● JU800B-1
玻璃吊轮
Sliding door roller



(最大玻璃承重150KG)
The glass maximum weight 150kg



● JU800A-2
管夹
Clamp fixing for track
(与墙体连接)
The connection with wall



● JU800A-3
管夹
Clamp fixing for track
(与玻璃连接)
The connection with glass



● JU800A-4
管夹
Clamp fixing for track
(与玻璃连接)
The connection with glass



● JU800A-5L
止动器
Door stop



● JU800A-5R
止动器
Door stop



● JU800A-6
止动器
Door stop



即施妥玻璃连接件系列

JUSTOR PROFESSIONAL GLASS FITTINGS SERIES

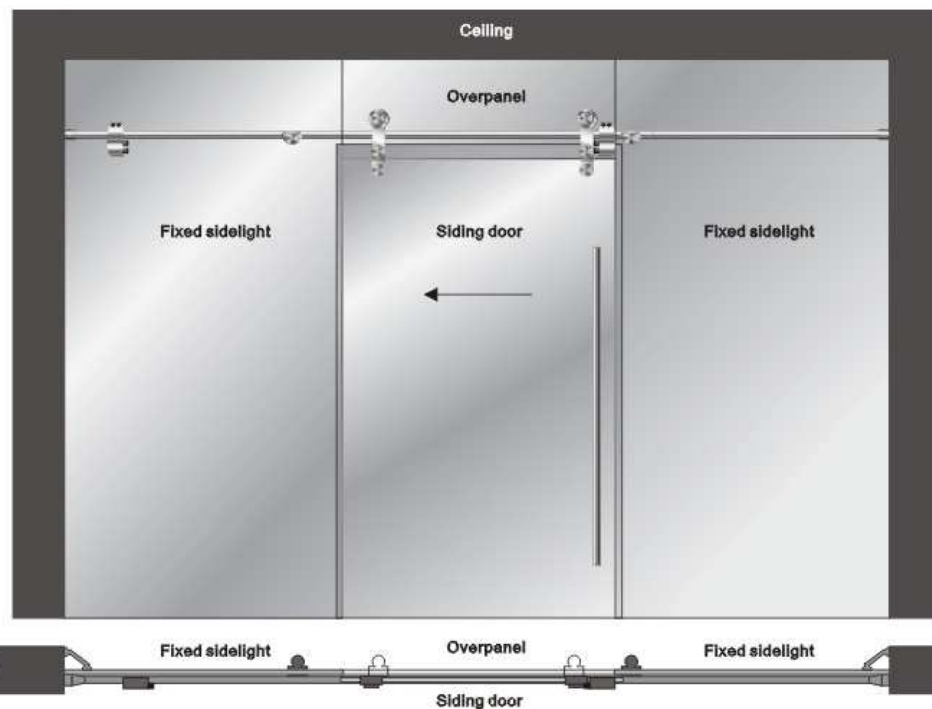
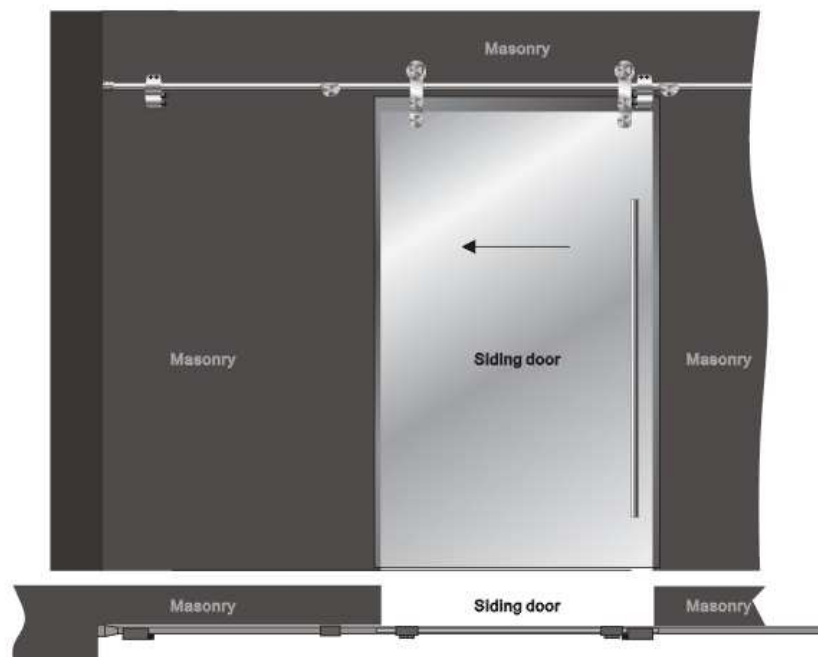

● 即施妥玻璃连接件系列

JUSTOR PROFESSIONAL GLASS FITTINGS SERIES

● 分别有两种连接玻璃的连接帽可供顾客选择，主要是用于玻璃连接。
Two kinds options of glass connection, mainly used for clamping glass.

● 可供订做材质：**钛金** **镜面** **拉丝**
Materials for ordering: titanium mirror satin



● **JU800A-7**
止动器
Door stop

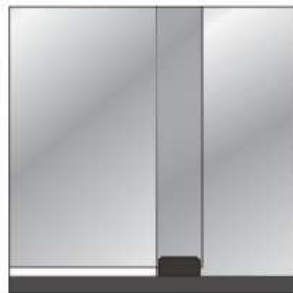

● **JU800A-9**
止摆器(不锈钢)
Floor guide



● **JU800A-8**
管与墙体固定件
Sliding sleeve

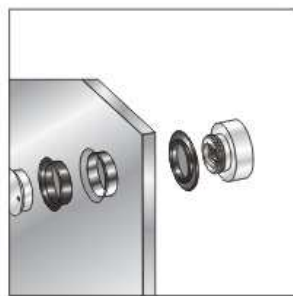

● **JU800F-1**
玻璃与墙体固定件
Single point fixing
(不可调节, 高度6.5mm)
Not adjustable, 6mm

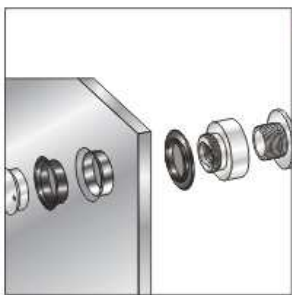

● **JU800F-2**
玻璃与墙体固定件
Single point fixing
(可调节, 调节节位2.5至11.5mm)
Adjustable, adjusted 2.5mm—11.5mm

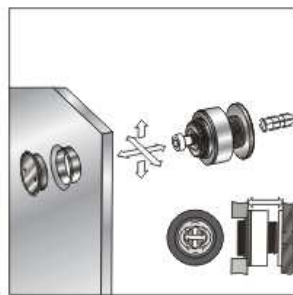

● **JU800F-3**
玻璃与墙体固定件
Single point fixing
(可调节, 调节节位11.5至14.5mm)
Adjustable, adjusted 11.5mm—14.5mm

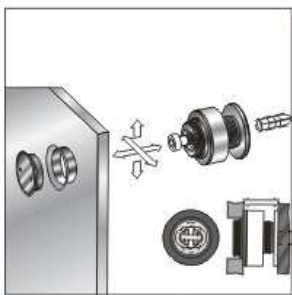

● **JU800F-4**
玻璃与墙体固定件
Single point fixing
(可调节加强型, 调节节位14.5至18.5mm)
Adjustable, adjusted 14.5mm—18.5mm

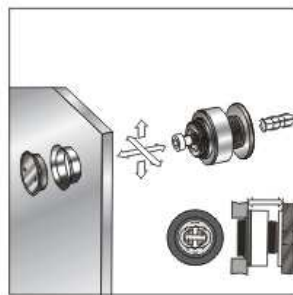

● **JU800F-5**
玻璃与墙体固定件
Single point fixing
(可调节加强型, 调节节位18.5至24.5mm)
Adjustable and strengthened, adjusted 18.5mm—24.5mm



● F1-F5可根据客户要求订做
We can manufacture according to customers' requirement.

● 即施妥玻璃连接件系列

JUSTOR PROFESSIONAL GLASS FITTINGS SERIES

即施妥玻璃连接件系列 ●

JUSTOR PROFESSIONAL GLASS FITTINGS SERIES

● 分别有两种连接玻璃的连接帽可供顾客选择，主要是用于玻璃连接。
Two kinds options of glass connection, mainly used for clamping glass.

● 可供订做材质：**钛金** **镜面** **拉丝**
Materials for ordering: titanium mirror satin

● **JU800F-6**
连接帽
Two kinds connecting for gales hole



斜口连接帽
Countersunk holes connecting

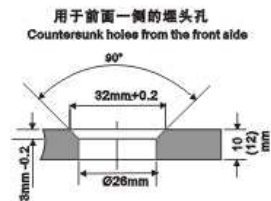

用途：分别有两种连接玻璃的连接帽可供顾客选择，主要是用于玻璃与钢结构的连接。
Use: two kinds options of glass connection, mainly used for clamping glass.

● **JU800F-7**
连接帽
Two kinds connecting for gales hole



直口连接帽
Flat holes connecting

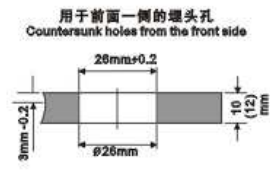

● **JU800E-1**
单杆固定件
Glass/wall Corner Connector
(玻璃与玻璃连接, 双头可调角度)
Connection for connecting wall and glass, both sides can adjusted angle

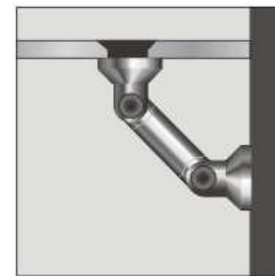

● **JU800E-2**
单杆固定件
Glass/wall Corner Connector
(墙体与玻璃连接, 双头可调角度)
Connection for connecting wall and glass, both sides can adjusted angle



● **JU800E-3**
单杆固定件
Glass/wall Corner Connector
(墙体与玻璃连接, 单头可调角度)
Connection for connecting wall and glass, just one sides can adjusted angle



● **JU800E-4**
双杆固定件
Clamping connector
(玻璃与玻璃连接, 四头可调角度)
Connection for connecting wall and glass, four directions sides can adjusted angle

● 玻璃的安装和处理：

玻璃/玻璃边角对接装置，用于厚度为10毫米与12毫米的钢化玻璃。

● GLASS PREPARATION

For glass/glass corner connectors for 10mm and 12mm thick toughened glass.

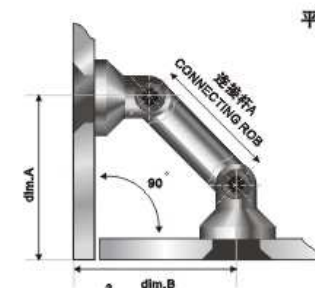

平面图(俯视图)
Planview



即施妥玻璃连接件系列

JUSTOR PROFESSIONAL GLASS FITTINGS SERIES

- JU800E-1、JU800E-2、JU800E-4连接杆尺寸与角度：(表中所述的尺寸单位为毫米，此处以10厚度为毫米的玻璃为例，对于其他厚度的玻璃，请依此类推。)
 JU800E-1、JU800E-2、JU800E-4 connecting rod size and angle: (Dim. in mm for 10mm glass. For other glass thickness please adapt accordingly.)

角度 Angle	连接杆尺寸 (单位毫米) Length of connecting rod and in mm			
	52.5	60	82	103
	A/B	A/B	A/B	A/B
90°	75	80	96	
95°	70	75	90	
100°	66	71	85	
105°	62	67	81	
110°	59	63	77	
115°	55	60	73	
120°	52	56	69	
125°	49	54	66	
130°	47	51	63	
135°	44	48	60	
180°	25	28.5	39.5	



A



B



C



D

- JU800E
 连接杆
 Connecting rod

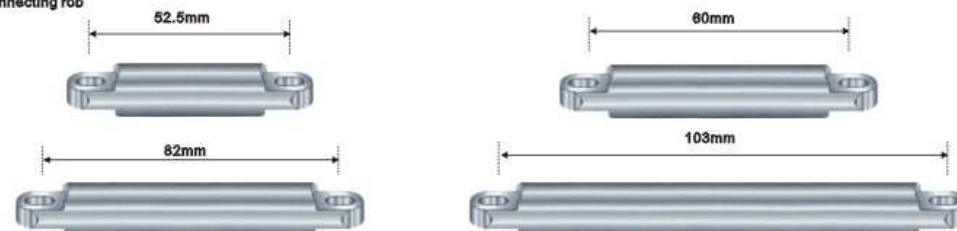

- 结构部件与组装示例图：
 Components and assembly of the wall fixing



玻璃的安装和处理：玻璃/玻璃边角对接装置，用于厚度为10毫米与12毫米的钢化玻璃。
 For glass/glass corner connectors for 10mm and 12mm thick toughened glass.

- JU800T
 玻璃连接件系统专用工具
 Installation tool

用途：用于安装或拆除玻璃连接件的专业工具
 Use: the tool for installing and backout glass connection



- 以上的配件用于进行挠性连接(活动连接)，包括对玻璃之间的互相连接，和与天花板、墙壁、地板等方面的挠性连接(活动连接)，以及可以应用于其他任何需要活动连接的地方。建筑偏差可以通过各种手段进行补偿。

The following fittings offer great flexibility in the positioning and connecting of glass sheets to each other, or the floor, ceiling, walls—wherever you want. Building tolerances can be compensated for by means of a variety of adjustment options.

工程名录

DIRECTORY

(篇幅有限不能尽列, 排名不分前后, 在此开达全体员工向尊敬的客户致谢)
 (Sequence is at random, and not all clients are listed due to the limited space.
 Here KAJIDA personnel wish to thank all the clients.)

北京市中国国际贸易中心
 国家体育总局
 北京市恒基中心
 北京市现代城
 北京市世纪金源大酒店
 北京市东方广场
 北京市数码大厦
 北京市长远天地
 北京市海龙电子城
 北京市大红门服装城
 上海春申汽车商贸城
 上海松江大学城
 上海铁道宾馆
 上海联谊大厦
 上海上岛咖啡
 上海莘园花园
 重庆市融桥半岛地产
 重庆市政府办公楼
 重庆市临江装饰城
 重庆市宏帆国际会议中心
 重庆市育才中学
 重庆市合川新世纪商城
 广州市珠江新城
 广州市富力广场
 广州市时代广场
 广州市美居中心
 广州市国龙大厦
 广州市中山八路儿童世界
 广州市东埔广场
 广州市花都机场
 广州琶洲国际会展中心
 深圳龙岗碧湖假日酒店
 深圳百事可乐公司
 深圳南山育德家园
 深圳电视台
 深圳皇岗山海轩宾馆
 深圳龙华万众服装批发市场
 沈阳市中兴商业大厦
 沈阳市新世界百货
 沈阳市东北大学科技馆
 沈阳市皇姑区体育馆
 鞍山市四隆购物广场
 鞍山市妇婴医院
 鞍山市鞍钢会议楼
 海城市大和建材市场
 长春市丰田汽车销售中心
 长春市世纪电影城
 长春市北方证券
 长春市长白山宾馆
 锦州市渤海大学
 锦州市凌水豪苑
 锦州市双华开发
 锦州市金厦开发
 大连市长兴购物中心
 松原市阳光商城

吉林市劳动宾馆
 中山市石岐大信新都会
 中山市古镇国贸大厦
 中山市石岐进出入境大楼
 珠海市中山大学
 珠海市华策大酒店
 温州市数码科技广场
 温州市新南亚大酒店
 温州市瑞安国际大酒店
 温州市机场
 贵阳市中共贵阳市委大楼
 贵阳市金筑大酒店
 贵阳市中天花园
 遵义市艺术中心
 安顺市公安局
 贵州省黔南州移动通讯公司
 毕节市电视台
 六盘水市万马商城
 凯里市政府大楼
 贵阳市风起都市花园
 杭州市星星港湾商业区
 杭州市四季高大酒店
 浙江省明珠商业中心
 浙江省商业学院
 杭州市黄龙商业区
 新疆美克大厦
 新疆银都酒店
 新疆伊犁州将军大酒店
 新疆昌吉州天九大厦
 新疆阿克苏市信用联社
 新疆新天大厦
 南宁市谷埠街时代广场
 南宁市白云小区-阳光花园
 南宁市金湾花城商业街
 南宁市万兴大酒店
 南宁市数码商业广场
 南宁市二运汽车站
 南宁市新城国际中心大厦
 南宁市友爱客运中心
 南宁市中达进口汽车展览厅
 南宁市南湖广场
 南宁市广西日报社大楼
 南宁市人防战备公司大楼
 柳州市柳铁文化宫
 太原市华寓国际精品商厦
 太原市天隆商务大厦
 太原市鸿金宝购物广场
 太原市圣亚品牌服饰广场
 太原市御花园假日大酒店
 太原市赛格数码中心
 太原市梨园发展中心
 太原市长江岳阳楼大酒店
 太原市东大盛世华庭
 山西省太原市安泰大厦
 榆次市烟草大厦



广州市花都机场



北京市东方广场



广州琶洲国际会展中心



北京市数码大厦



北京市中国国际贸易中心



北京市海龙电子城



北京市恒基中心



广州市美居中心



广州市中山八路儿童世界



广州市时代广场



广州市田龙大厦



北京市现代城

開達
元信
立百年
新