

Code: 105-4



Golden  
World  
Trading  
Group

[www.GoldenWTG.org](http://www.GoldenWTG.org)

# 60 Casement Series

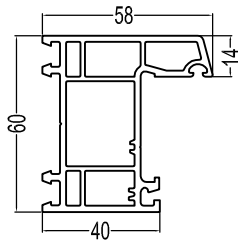

60Casement Frame(A)  
P60K(A)  
0.87kg/m

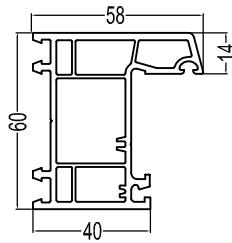

60Casement Frame(B)  
P60K(B)  
1.08kg/m

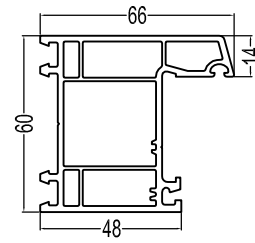

60Casement Frame(C)  
P60K(C)  
0.99kg/m

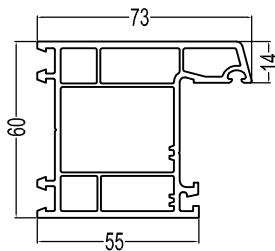

60Casement Frame(D)  
P60K(D)  
1.14kg/m

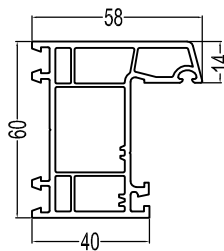

60Casement Frame(E)  
P60K(E)  
0.98kg/m

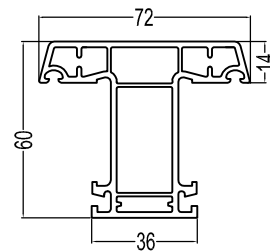

60Casement Mullion(A)  
P60ZT(A)  
0.89kg/m

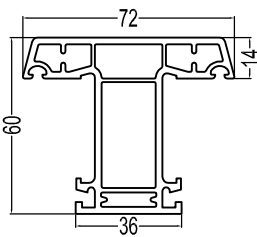

60Casement Mullion(B)  
P60ZT(B)  
1.15kg/m

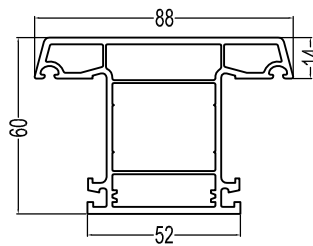

60Casement Mullion(D)  
P60ZT(D)  
1.2kg/m

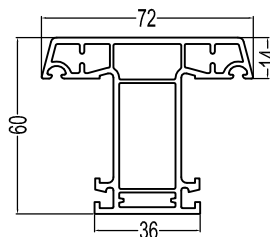

60Casement Mullion(E)  
P60ZT(E)  
1.03kg/m

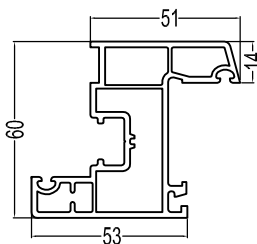

60Inswing Sash(A)  
P60NKCS(A)  
1.05kg/m

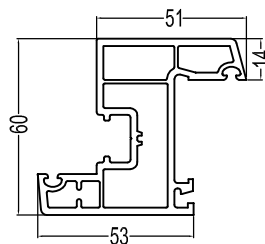

60Inswing Sash(B)  
P60NKCS(B)  
1.12kg/m

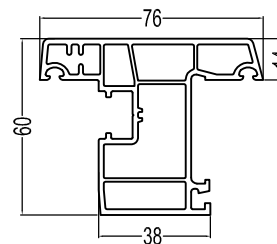

60 Outswing Sash  
P60WKCS  
1.05kg/m

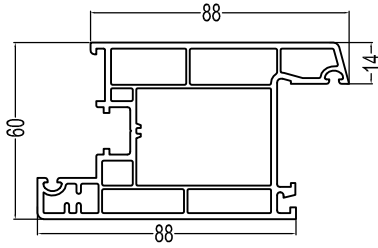

60Casement Inward Door (A)  
P60NKMS (A)  
1.38kg/m

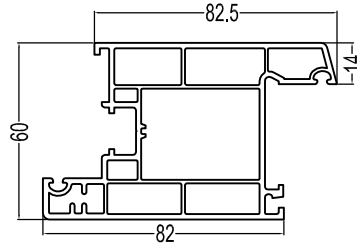

60Casement Inward Door (B)  
P60NKMS (B)  
1.2kg/m

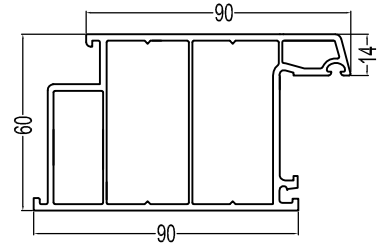

60Casement Door Sash  
P60MS  
1.3kg/m

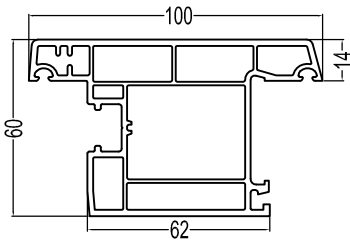

60Casement Outward Door  
P60WKMS  
1.38kg/m

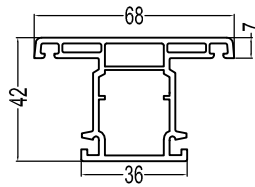

42Sash Mullion  
P42MSZT  
0.72kg/m

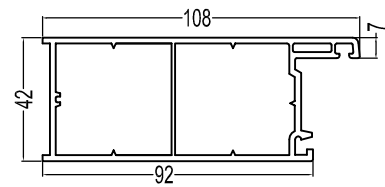

42Casement Door Sash  
P42MS  
1.0kg/m

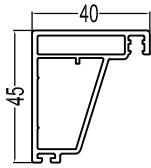

60Casement Insect Screen  
P60SS  
0.47kg/m

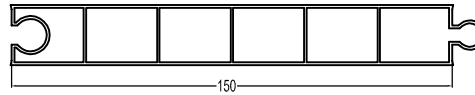

20x150 Door Panel  
20x150MB  
0.7kg/m

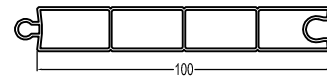

15x100 Door Panel  
15x100MB  
0.42kg/m

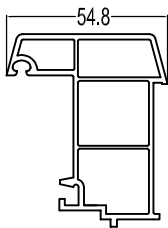

60Inswing Mullion  
P60NKFT  
0.7kg/m

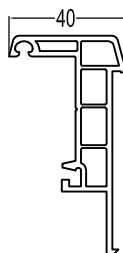

60Inswing Mullion-1  
P60NKFT-1  
0.55kg/m

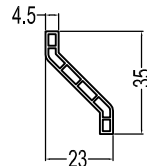

Jalousie window vane  
BY  
0.16kg/m

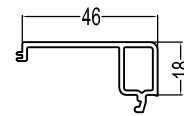

Louver bead  
BYT  
0.26kg/m

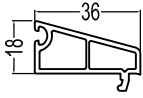

60Casement Single Glazing Bead  
P60DY  
0.24kg/m

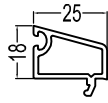

60Casement Double Glazing Bead(A)  
P60SY(A)  
0.2kg/m

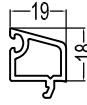

60Casement Double Glazing Bead(B)  
P60SY(B)  
0.175kg/m

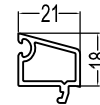

60Casement Double Glazing Bead(C)  
P60SY(C)  
0.185kg/m

## 60 Casement Series (L)

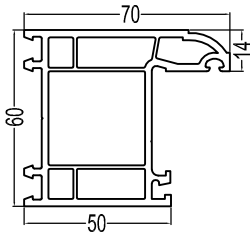

60Casement Frame(LA)  
P60K(LA)  
1.1kg/m

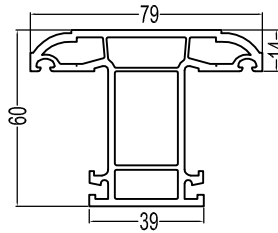

60Casement Mullion(LA)  
P60ZT(LA)  
1.12kg/m

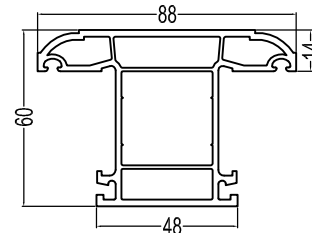

60Casement Mullion(LB)  
P60ZT(LB)  
1.2kg/m

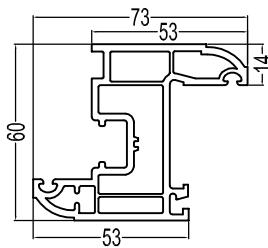

60Inswing Sash(LB)  
P60NKCS(LB)  
1.14kg/m

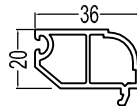

60Sliding Single Glazing Bead(L)  
P60DY(L)  
0.28kg/m

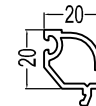

60Sliding Double Glazing Bead(L)  
P60SY(LA)  
0.19kg/m

## 60 Casement Series (S)

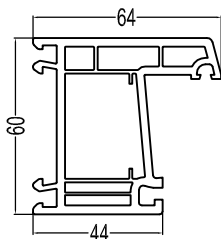

60Casement Frame(S)  
P60K(s)  
1.25kg/m

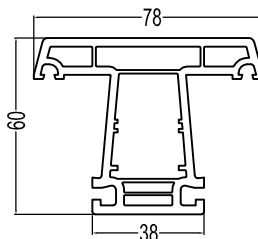

60Casement Mullion(S)  
P60ZT(s)  
1.32kg/m

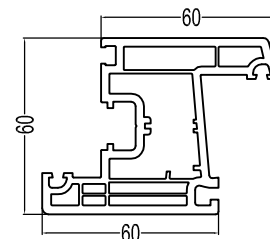

60Inswing Sash(S)  
P60NKCS(s)  
1.48kg/m

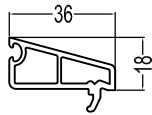

60Casement Single Glazing Bead(S)  
P60DY (S)  
0.31kg/m

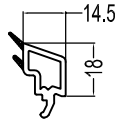

60Casement Double Glazing Bead(S)  
P60SY (S)  
0.17kg/m

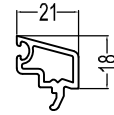

60Casement Double Glazing Bead(S-1)  
P60SY (S-1)  
0.22kg/m

## 66 Casement Series

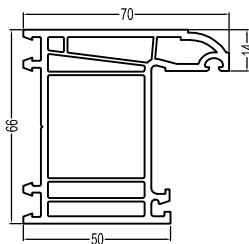

66Casement Frame (A)  
P66K (A)  
1.23kg/m

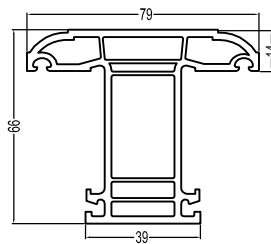

66Casement Mullion(A)  
P66ZT (A)  
1.21kg/m

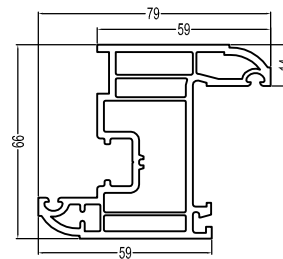

66Inswing Sash(A)  
P66NKCS (A)  
1.23kg/m

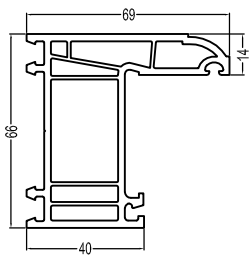

66Casement Frame (B)  
P66K (B)  
1.19kg/m

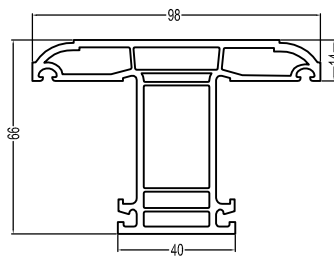

66Casement Mullion(B)  
P66ZT (B)  
1.35kg/m

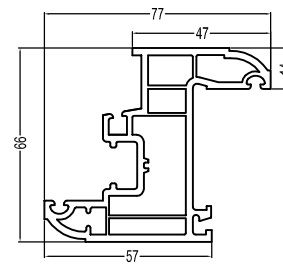

66Inswing Sash(C)  
P66NKCS (C)  
1.17kg/m

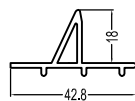

66Connecting Board  
P66PB  
0.18kg/m



66Mat Board  
P66DB  
0.3kg/m

# 66 Casement Series

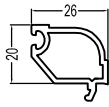

66Casement Double Glazing Bead(A)  
P66YT(A)-Dou  
0.22kg/m



66Casement Triple Glazing Bead(A)  
P66YT(A)-Thr  
0.17kg/m

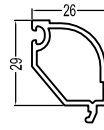

66Casement Double Glazing Bead(B)  
P66YT(B)-Dou  
0.25kg/m



66Casement Triple Glazing Bead(B)  
P66YT(B)-Thr  
0.22kg/m

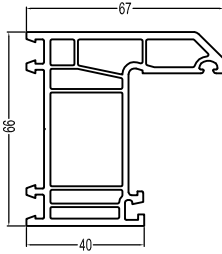

66Casement Frame(D)  
P66K(D)  
1.2kg/m

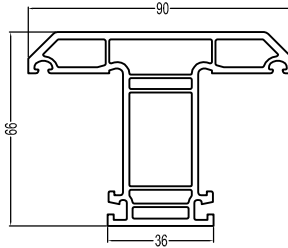

66Casement Mullion(D)  
P66ZT(D)  
1.31kg/m

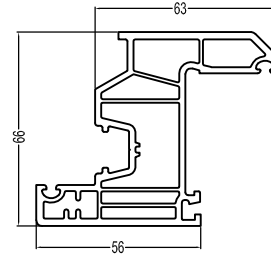

66Inswing Sash(D)  
P66NKCS(D)  
1.35kg/m

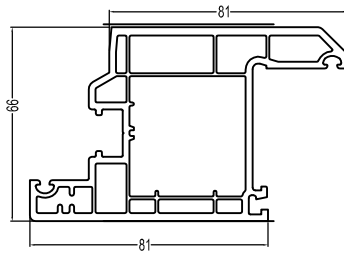

66Casement Inward Door(D)  
P66NKMS(D)  
1.7kg/m

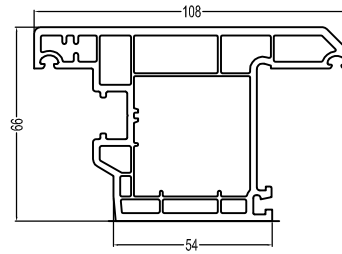

66Casement Outward Door(D)  
P66WKMS(D)  
1.7kg/m

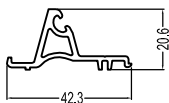

66Connecting Board(D)  
P66PB(D)  
0.22kg/m

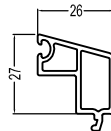

66Casement Double Glazing Bead(D)  
P66YT(D)-Dou  
0.25kg/m

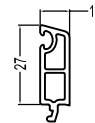

66Casement Triple Glazing Bead(D)  
P66YT(D)-Thr  
0.18kg/m

# 60 Sliding Series

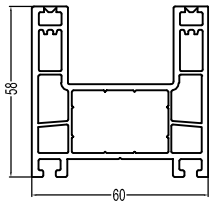

60Sliding Frame  
T60K  
1.02kg/m

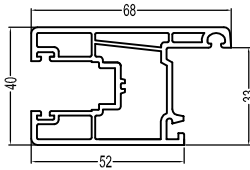

60/88Sliding Sash(A)  
T60/88S(A)  
0.86kg/m

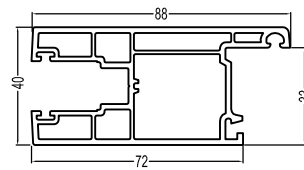

60Sliding Sash(B)  
T60S(B)  
1.1kg/m

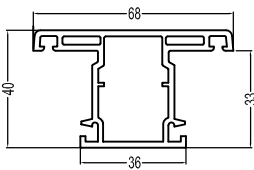

60/88Sash Mullion  
T60/88SZT  
0.7kg/m

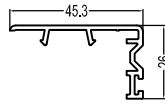

60/88Weather Strip  
T60/88FG  
0.21kg/m

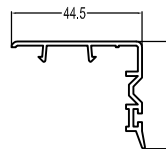

60/88Weather Strip(A)  
T60/88FG(A)  
0.24kg/m

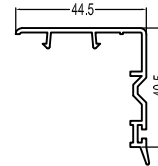

60Weather Strip(B)  
T60FG(B)  
0.26kg/m

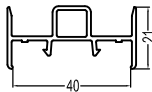

60Cover  
T60GM  
0.25kg/m



60/88Sliding Single Glazing Bead  
T60/88DY  
0.2kg/m



60Sliding Double Glazing Bead  
T60SY  
0.13kg/m

# 75 Sliding Series

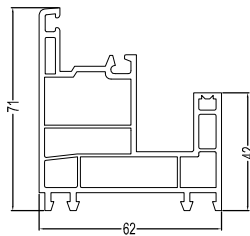

75 Single Sliding Frame  
T75DK  
1.0kg/m

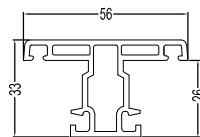

75Sash Mullion  
T75SZT  
0.52kg/m

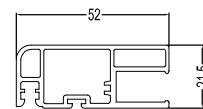

75/80Insect Screen(B)  
T75/80SS(B)  
0.48kg/m

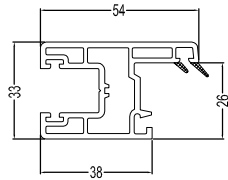

75Sliding Sash  
T75S  
0.67kg/m

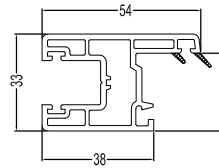

75Sliding Sash(B)  
T75S(B)  
0.62kg/m



75Sliding Single Glazing Bead  
T75DY  
0.15kg/m



75Sliding Double Glazing Bead  
T75SY  
0.11kg/m

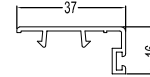

75Weather Strip  
T75FG  
0.17kg/m

## 80 Sliding Series

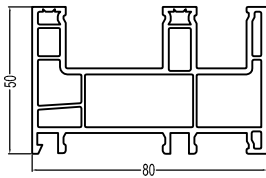

80Sliding Frame  
T80K  
1.12kg/m

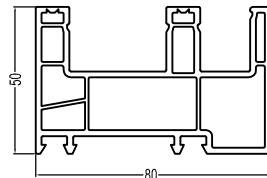

80Sliding Frame(A)  
T80K(A)  
1.12kg/m

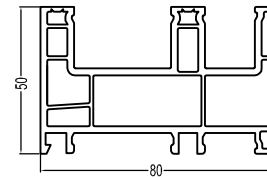

80Sliding Frame(D)  
T80K(D)  
1.22kg/m

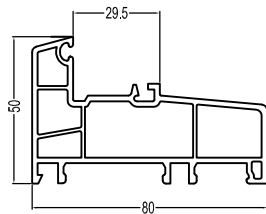

80Upper Sliding Frame  
T80LK  
0.9kg/m

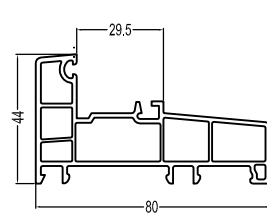

80Upper Sliding Frame(B)  
T80LK(B)  
0.82kg/m

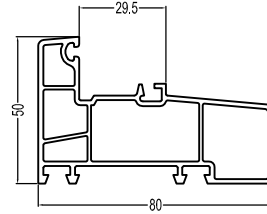

80Upper Sliding Frame(C)  
T80LK(C)  
0.9kg/m



# 80 Sliding Series

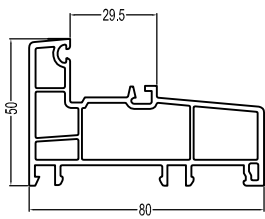

80Upper Sliding Frame(D)  
T80LK(D)  
1.01kg/m

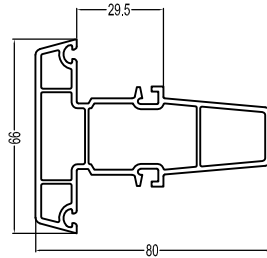

80Upper Sliding Transom  
T80LT  
0.93kg/m

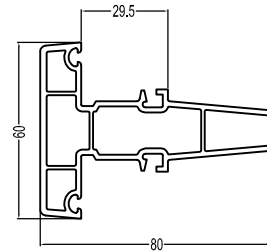

80Upper Sliding Transom(D)  
T80LT(D)  
1.02kg/m

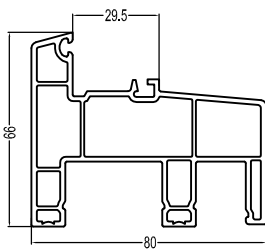

80 Transom Trame  
T80WLT  
1.17kg/m

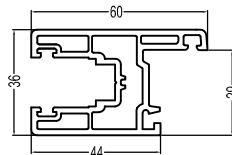

80Sliding Sash(A)  
T80S(A)  
0.76kg/m

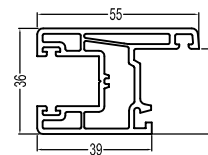

80Sliding Sash(B)  
T80S(B)  
0.68kg/m

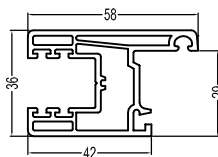

80Sliding Sash(C)  
T80S(C)  
0.76kg/m

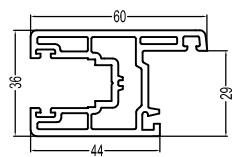

80Sliding Sash(D)  
T80S(D)  
0.82kg/m

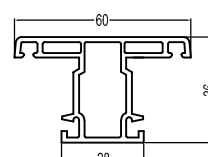

80Sash Mullion  
T80SZT  
0.62kg/m

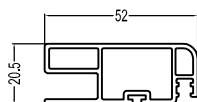

80/88Insect Screen(H)  
T80/88SS(H)  
0.43kg/m

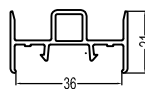

80Cover  
T80GM  
0.26kg/m

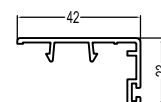

80Weather Strip(H)  
T80FG(H)  
0.2kg/m

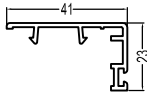

80Weather Strip  
T80FG  
0.2kg/m



80Sliding Single Glazing Bead  
T80DY  
0.15kg/m



80Sliding Double Glazing Bead  
T80SY  
0.11kg/m



80Sliding Double Glazing Bead-1  
T80SY-1  
0.1kg/m

# 80 Casement Sliding Series

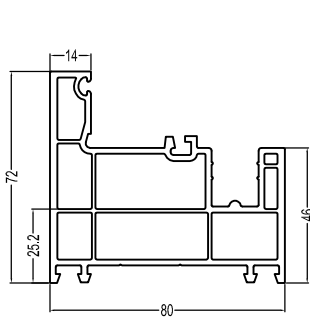

80 Sliding Tranlatory Frame(A)  
PT80K (A)  
1.45kg/m

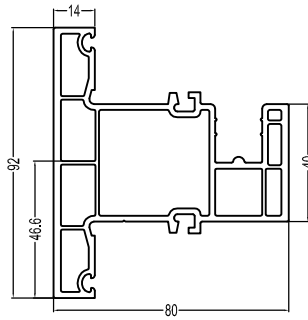

80 Sliding Tranlatory Mullion(A)  
PT80ZT (A)  
1.6kg/m

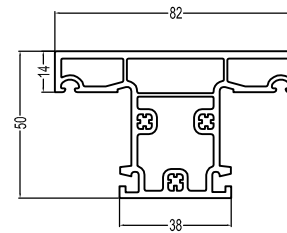

80 Sliding Tranlatory Sash Mullion(A)  
PT80SZT (A)  
1.2kg/m

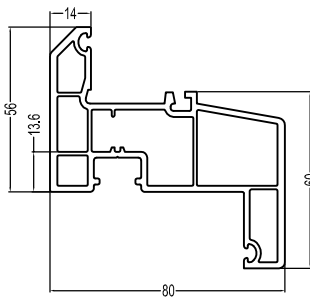

80 Sliding Tranlatory Small Sash(A)  
PT80XS (A)  
1.29kg/m

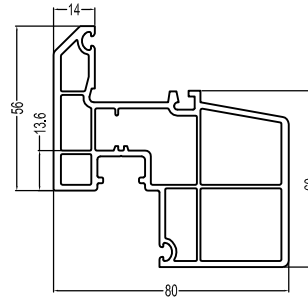

80 Sliding Tranlatory Big Sash(A)  
PT80DS (A)  
1.39kg/m



80 Sliding Tranlatory Weather Strip(A)  
PT80FG (A)  
0.1kg/m

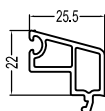

80 Sliding Single Tranlatory Glazing Bead  
PT80DY  
0.24kg/m



80 Sliding Tranlatory Double Glazing Bead(A)  
PT80SY (A)  
0.18kg/m



80 Sliding Tranlatory Double Glazing Bead(B)  
PT80SY (B)  
0.16kg/m

# 88 Sliding Series

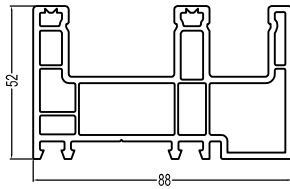

88 Sliding Frame (A)  
T88K (A)  
1.4kg/m

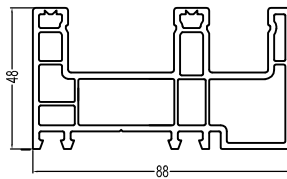

88 Sliding Frame (B)  
T88K (B)  
1.25kg/m

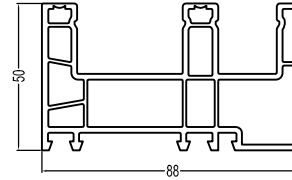

88 Sliding Frame (C)  
T88K (C)  
1.34kg/m

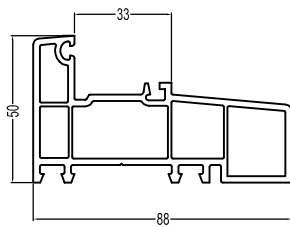

88 Upper Sliding Frame  
T88LK  
1.06kg/m

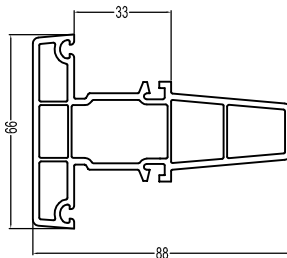

88 Upper Sliding Transom  
T88LT  
1.07kg/m

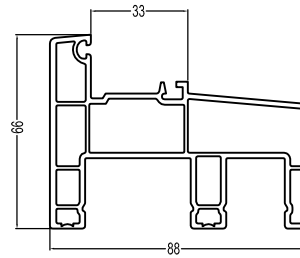

88 Transom Trame  
T88WLT  
1.35kg/m

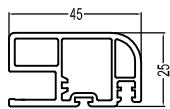

88 Insect Screen  
T88SS  
0.48kg/m

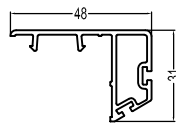

88 Four rail  
T88SGFG  
0.28kg/m

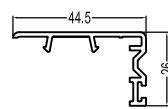

60/88 Weather Strip  
T60/88FG  
0.21kg/m

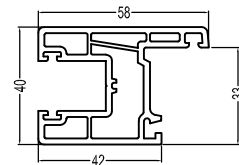

88 Sliding Sash (B)  
T88S (B)  
0.76kg/m

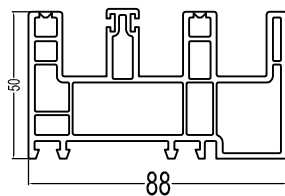

88 Four Track Sliding Frame  
T88SGK  
1.35kg/m

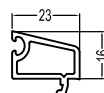

60/88 Sliding Single Glazing Bead  
T60/88DY  
0.2kg/m



88 Sliding Double Glazing Bead  
T88SY  
0.12kg/m

# Spare Parts

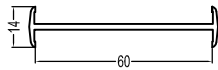

60Actionpanel  
60PT  
0.28kg/m

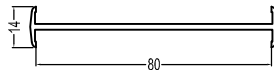

80Actionpanel  
80PT  
0.28kg/m

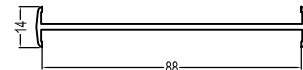

88Actionpanel  
88PT  
0.31kg/m

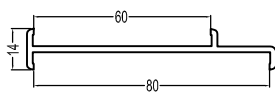

60/80Actionpanel  
60/80PT  
0.28kg/m

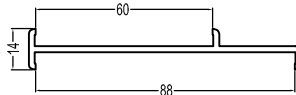

88/60Actionpanel  
88/60PT  
0.31kg/m

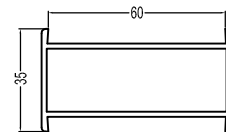

60Frame Connecting Profile  
60PG  
0.56kg/m

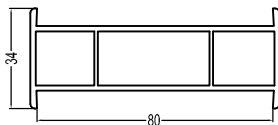

80Frame Connecting Profile(20)  
80PG(20)  
0.65kg/m

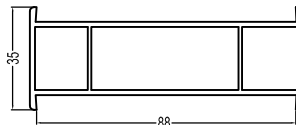

88Frame Connecting Profile  
88PG  
0.8kg/m



80Frame Connecting Profile (40)  
80PG(40)  
0.83kg/m

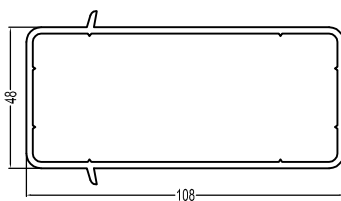

Big Frame Connecting Profile  
DPG  
1.05kg/m

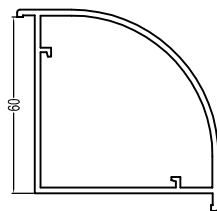

60Corner Profile(90)  
60ZJ(90)  
0.62kg/m

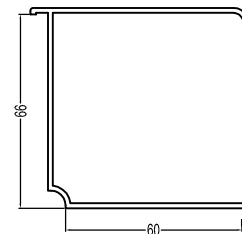

60/66Corner Profile(90)  
60/66FZJ(90)  
0.75kg/m

# Spare Parts

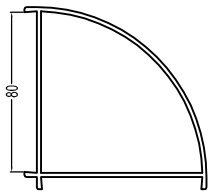

80Corner Profile(90)  
80ZJ(90)  
0.9kg/m

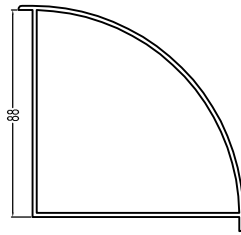

88Corner Profile(90)  
88ZJ(90)  
0.97kg/m

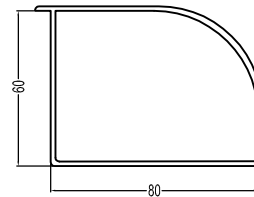

80/60Corner Profile(90)  
80/60ZJ(90)  
0.77kg/m

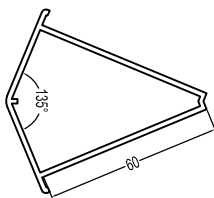

135Corner Profile(60/66)  
135ZJ(60/66)  
0.52kg/m

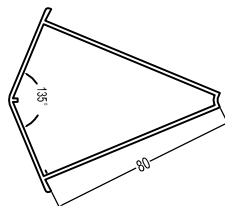

135Corner Profile(80)  
135ZJ(80)  
0.68kg/m

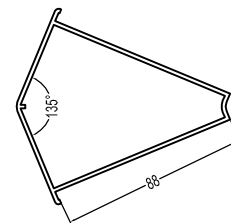

135Corner Profile(88)  
135ZJ(88)  
0.68kg/m

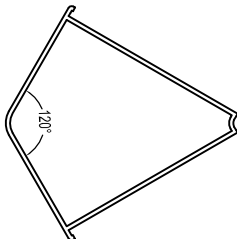

120° Corner Profile(80)  
120° ZJ(80)  
0.75kg/m

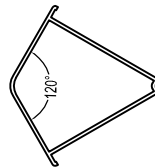

120° Corner Profile(60/66)  
120° ZJ(60/66)  
0.57kg/m

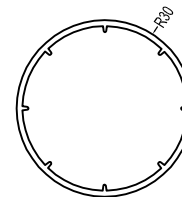

60Bay Tube  
60YG  
0.52kg/m

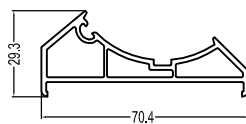

66Bay Tube socket  
66GZ  
0.49kg/m

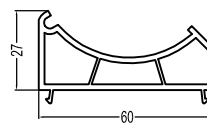

60Bay Tube socket  
60GZ  
0.5kg/m

# 60series window's node drawing

60in-swing

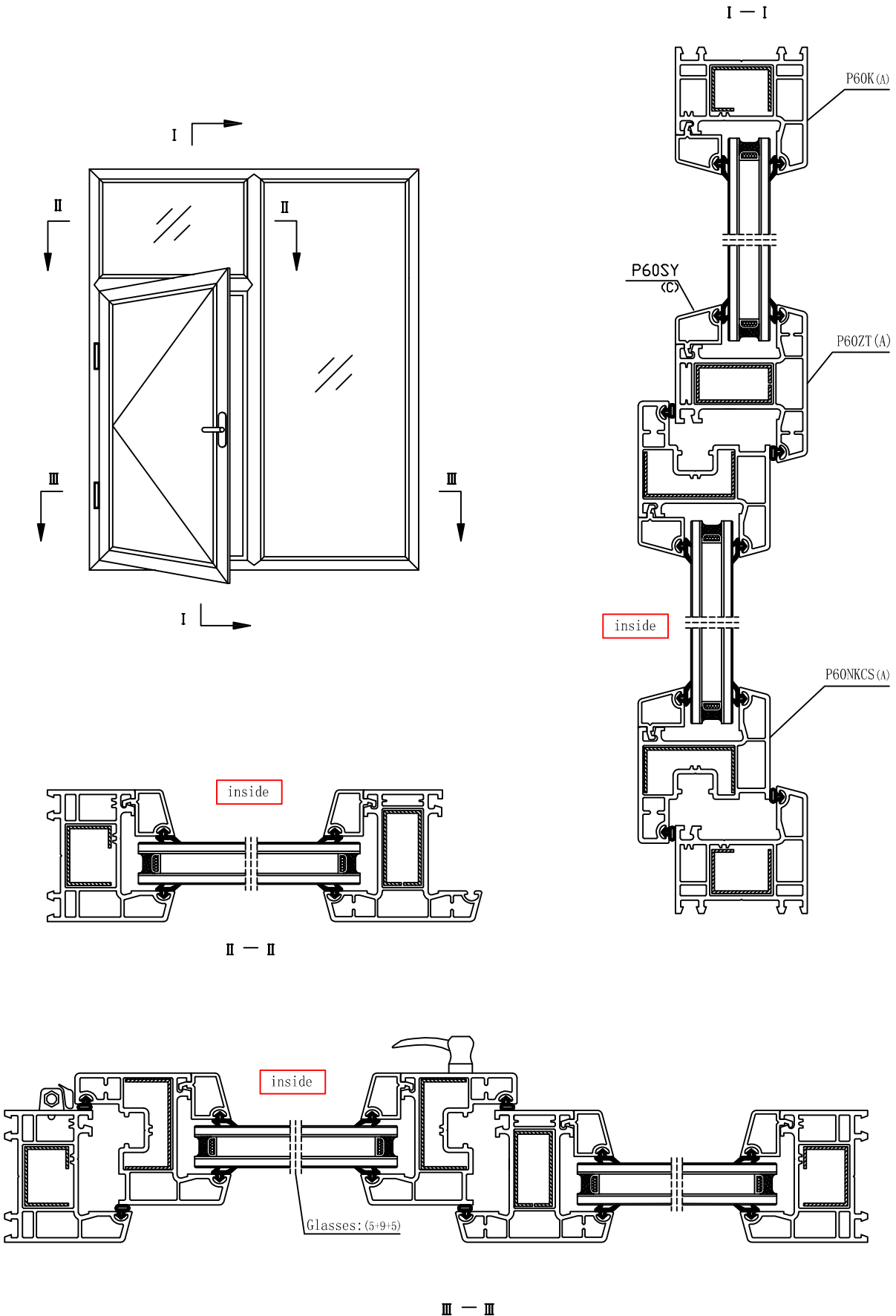

# 60series window's node drawing

## 60out-swing

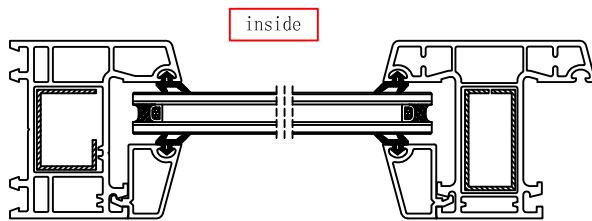
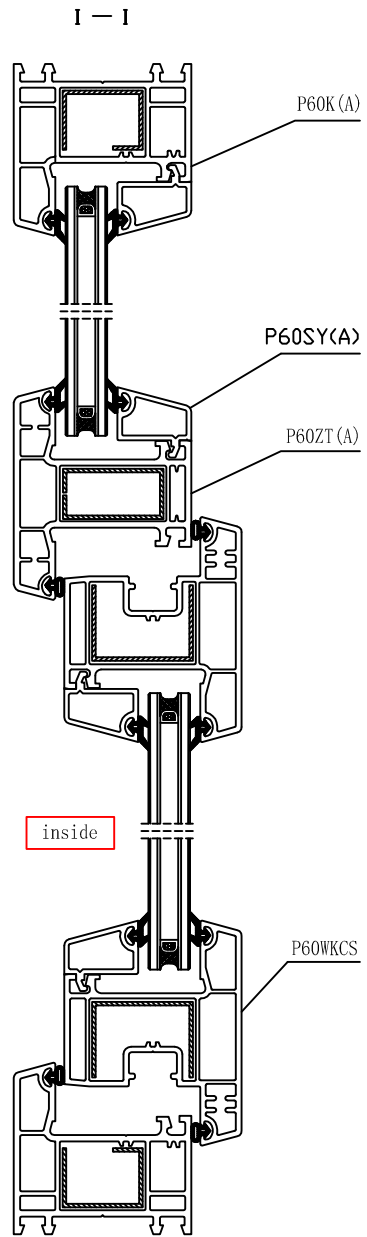
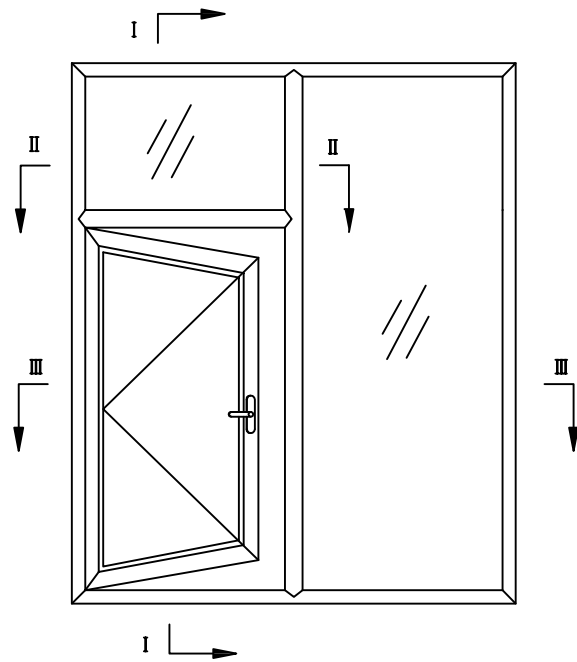

II - II

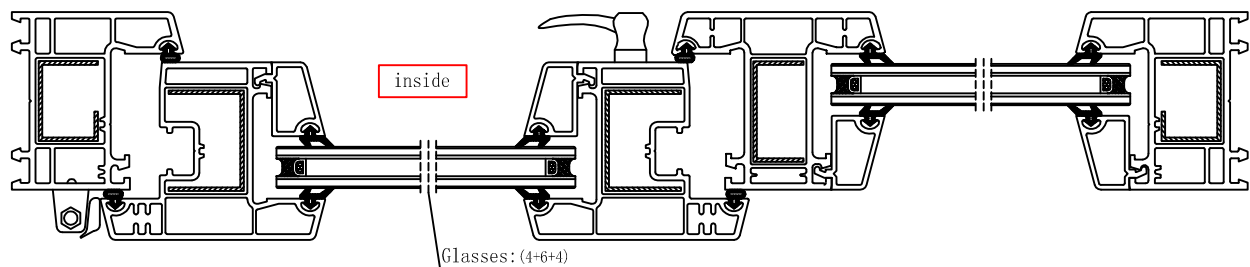

III - III

# 60series window's node drawing

## 60in-swing

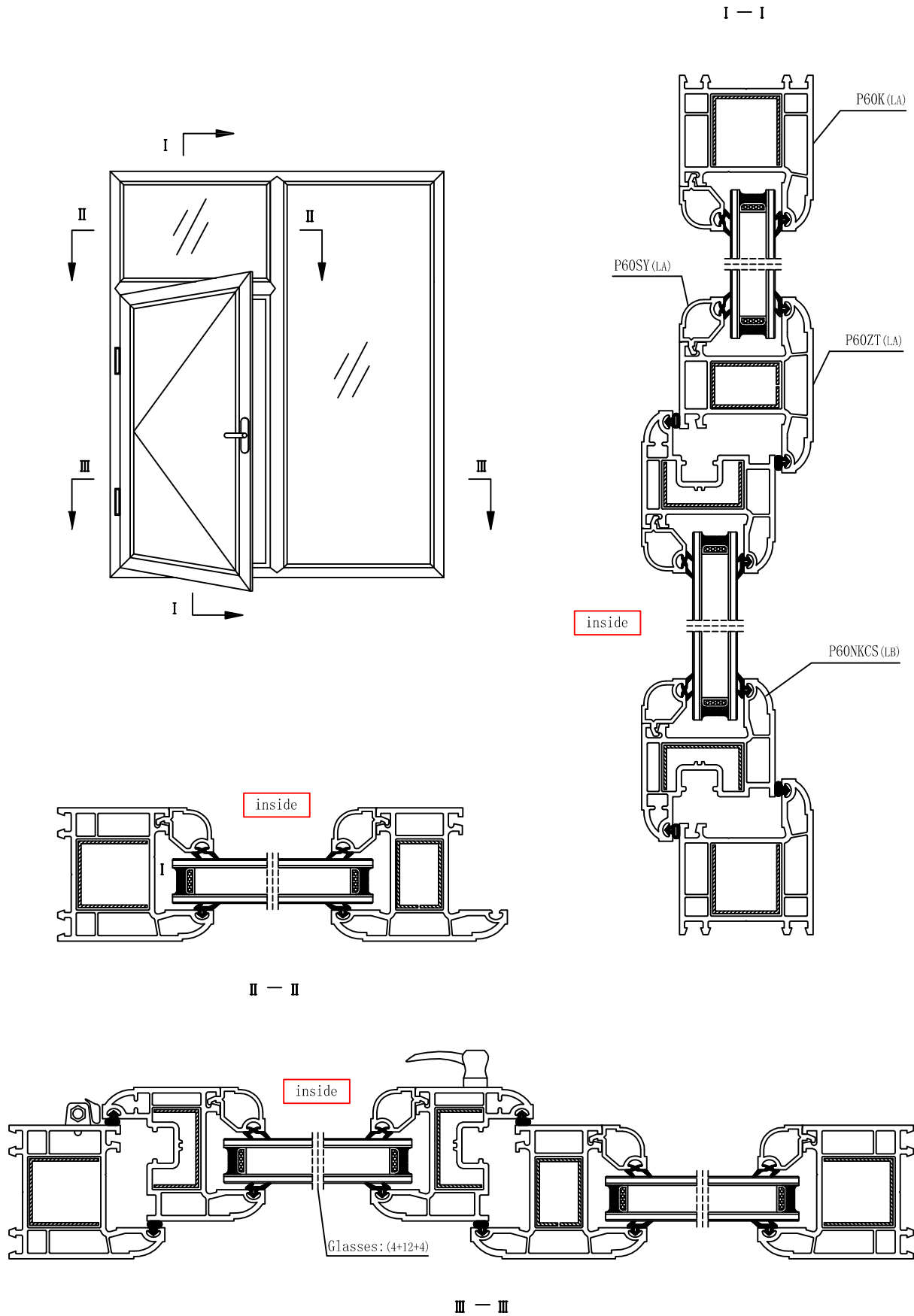



# 60series window's node drawing

## 60in-swing door

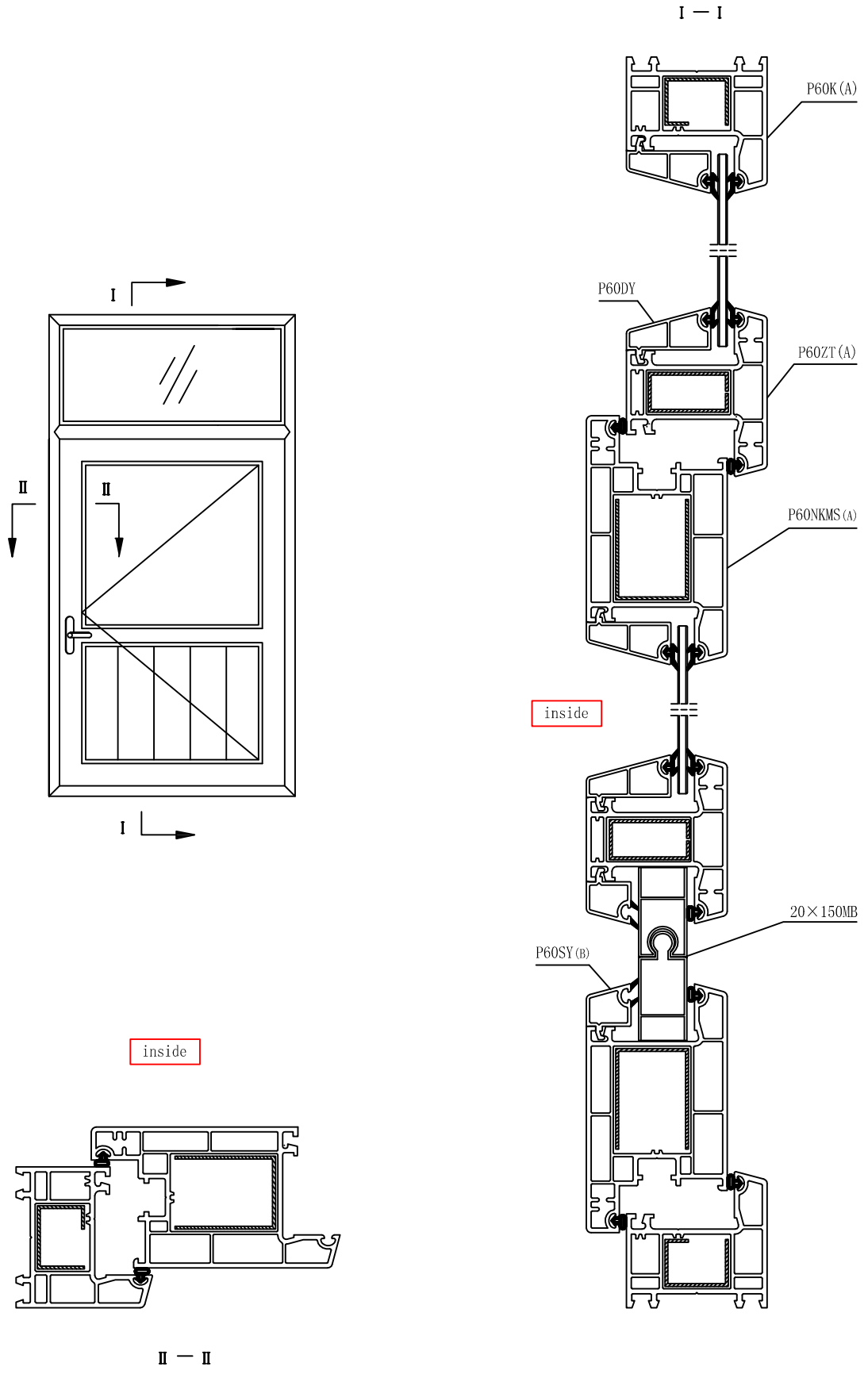

# 60series window's node drawing

## 60in-swing door

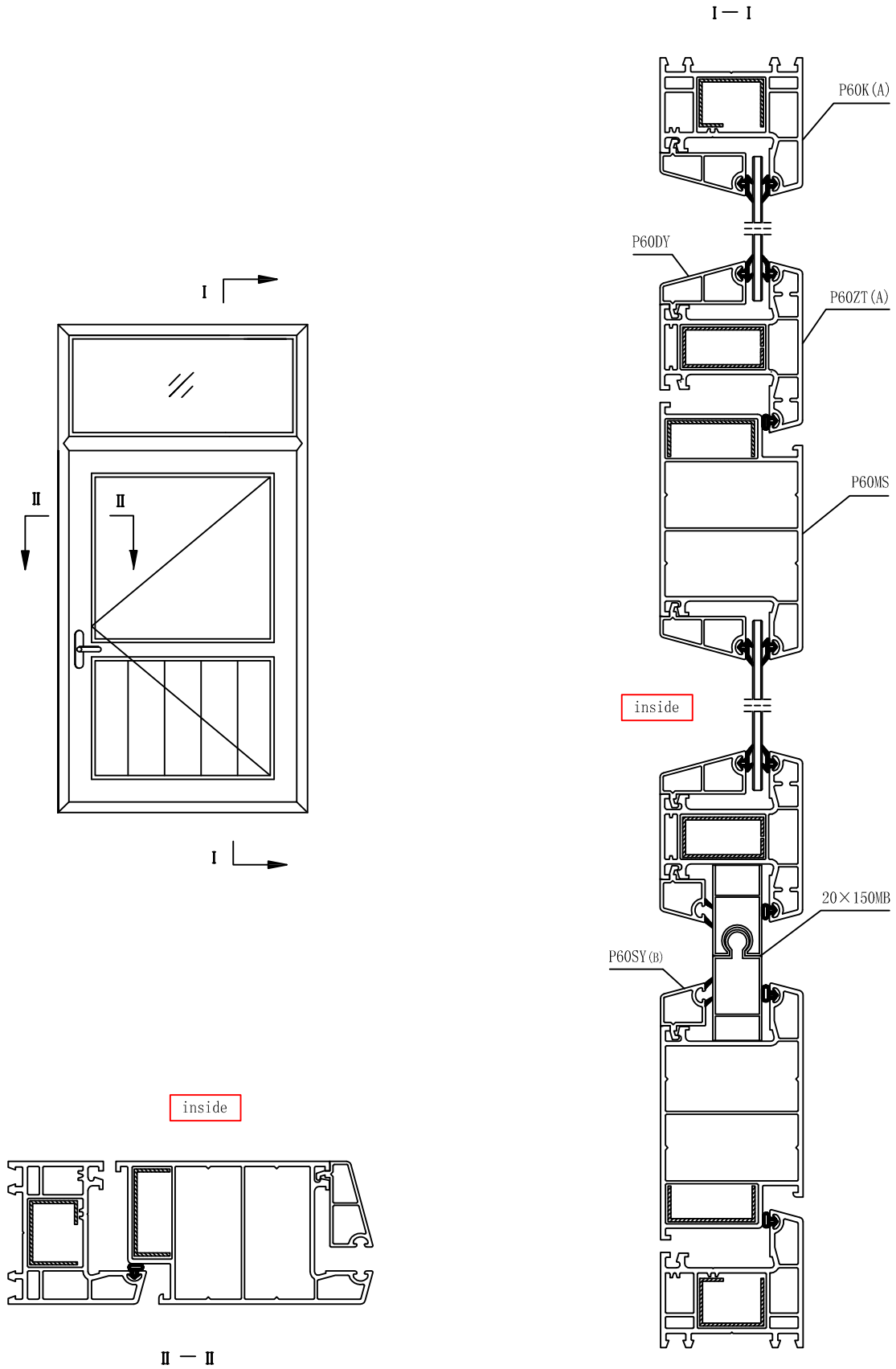

# 42series window's node drawing

## 42in-swing door

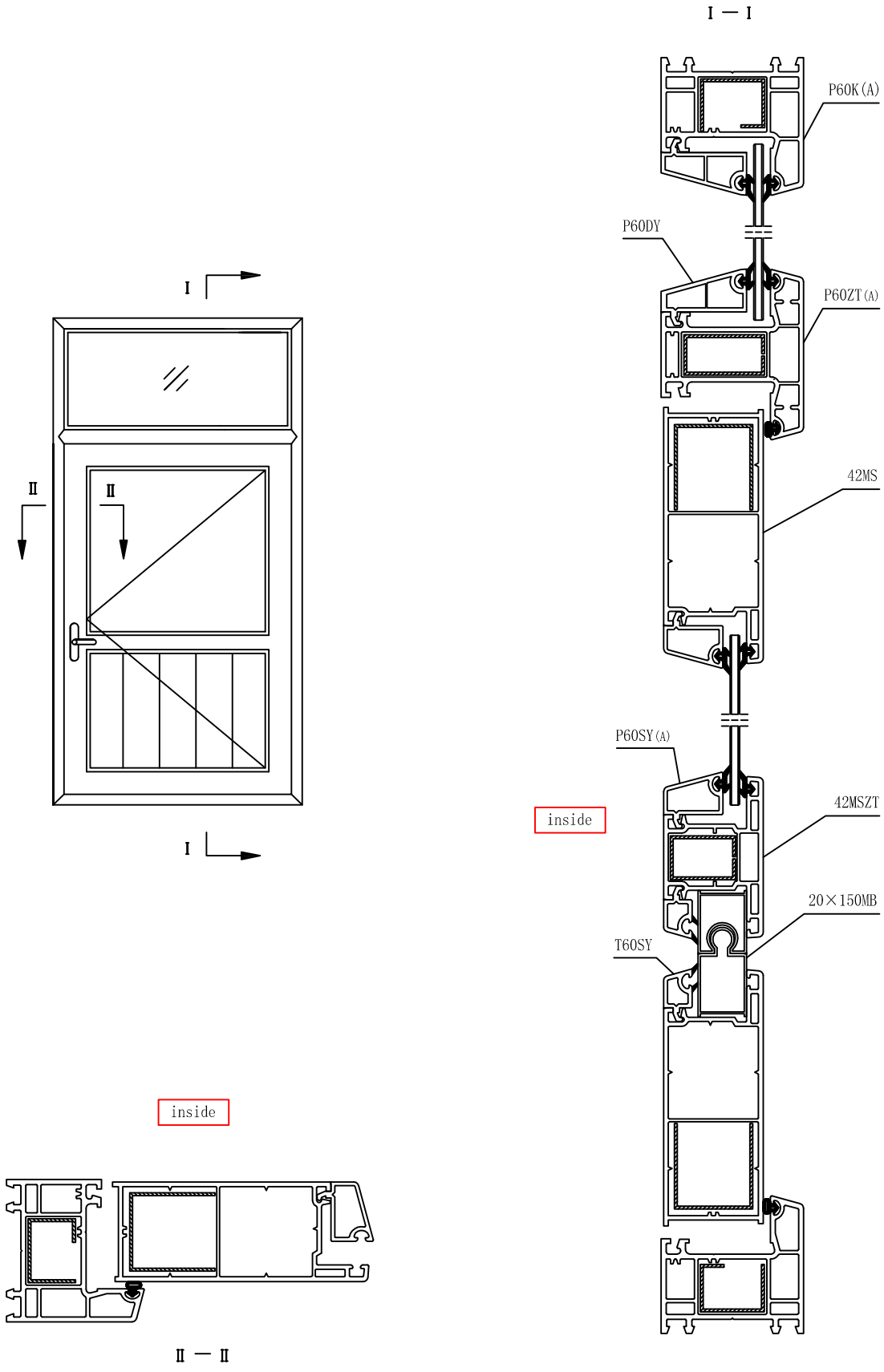

60series window's node drawing

60normal in-swing door

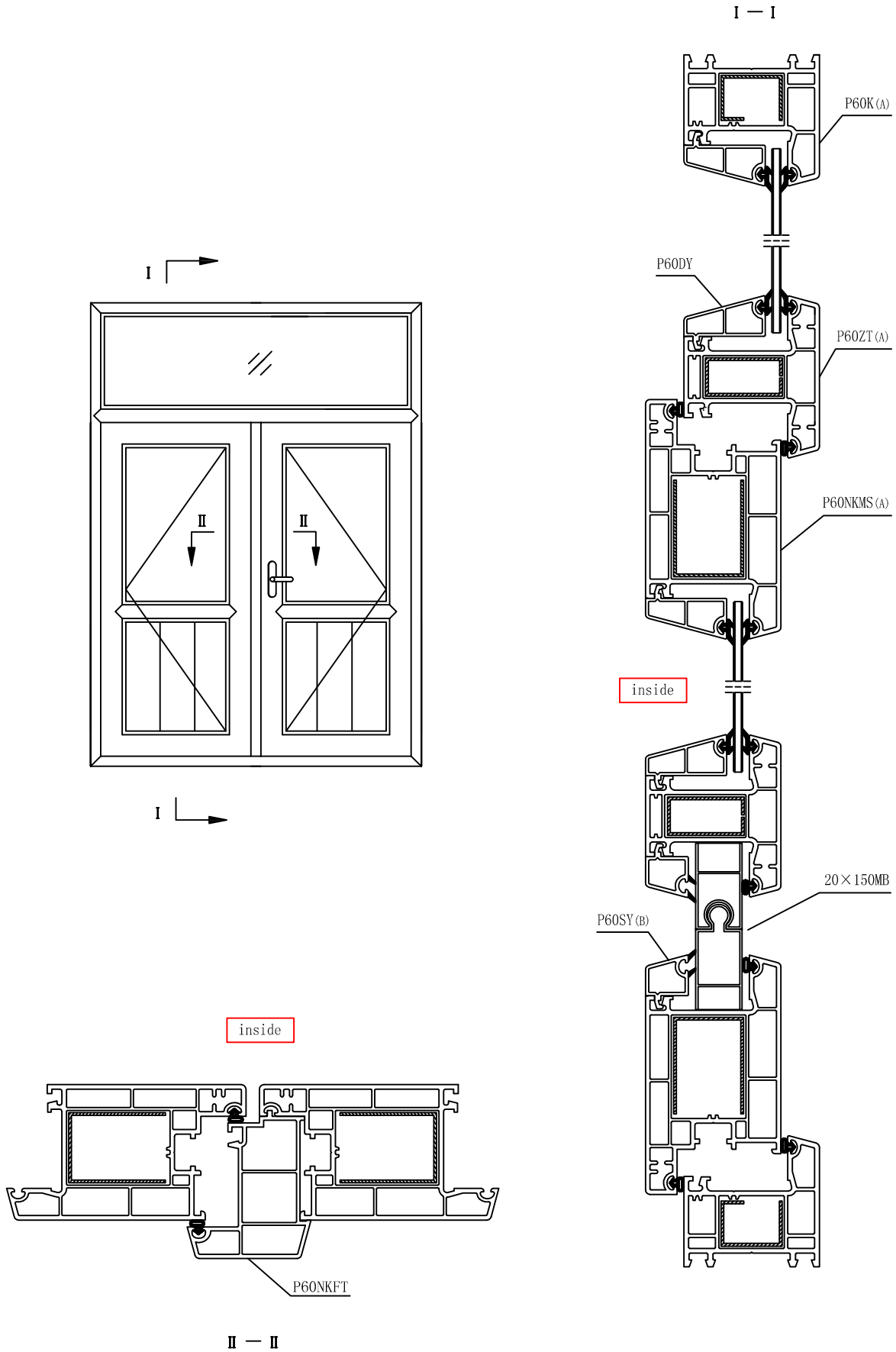

# 66series window's node drawing

## 66in-swing

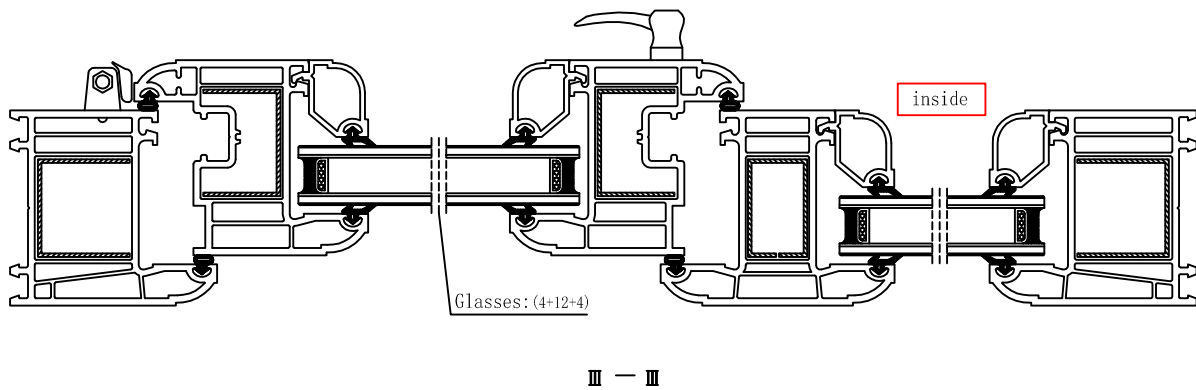
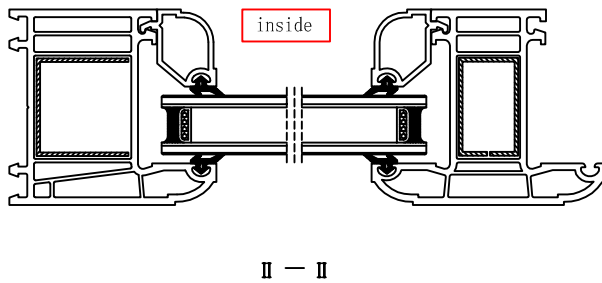
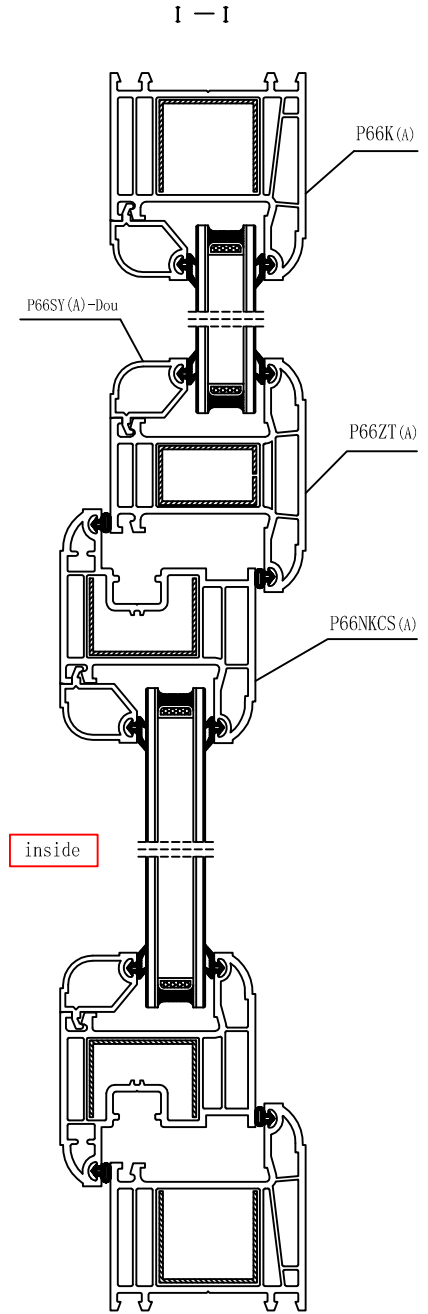
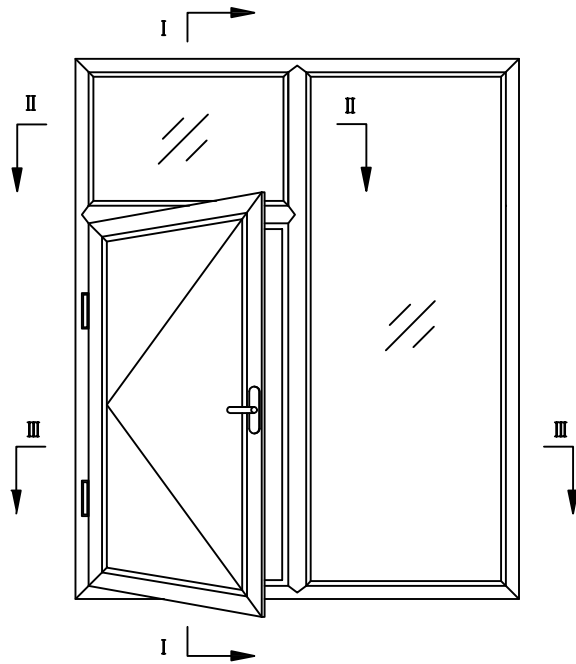

# 66series window's node drawing

66in-swing

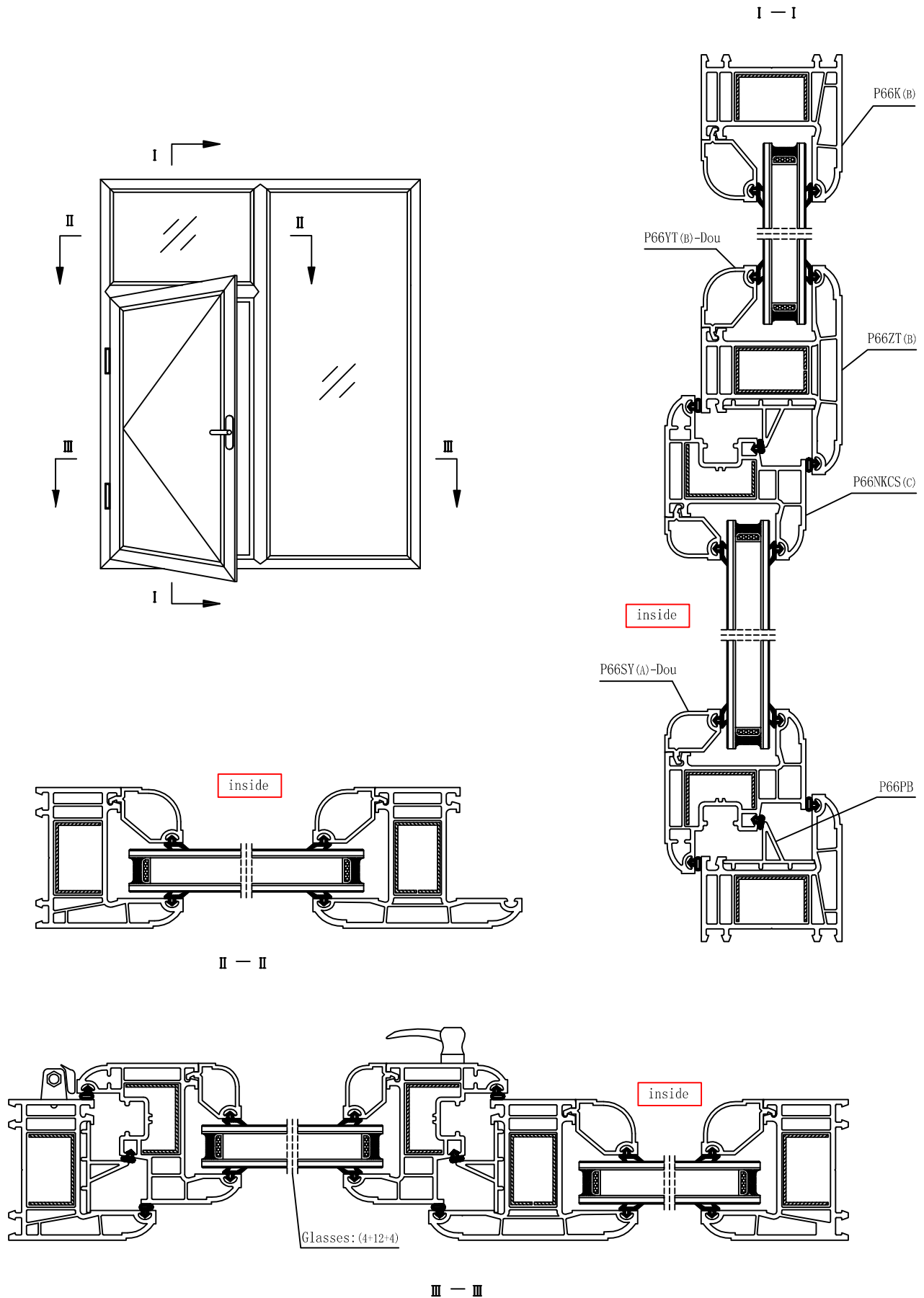

# 66series window's node drawing

66in-swing

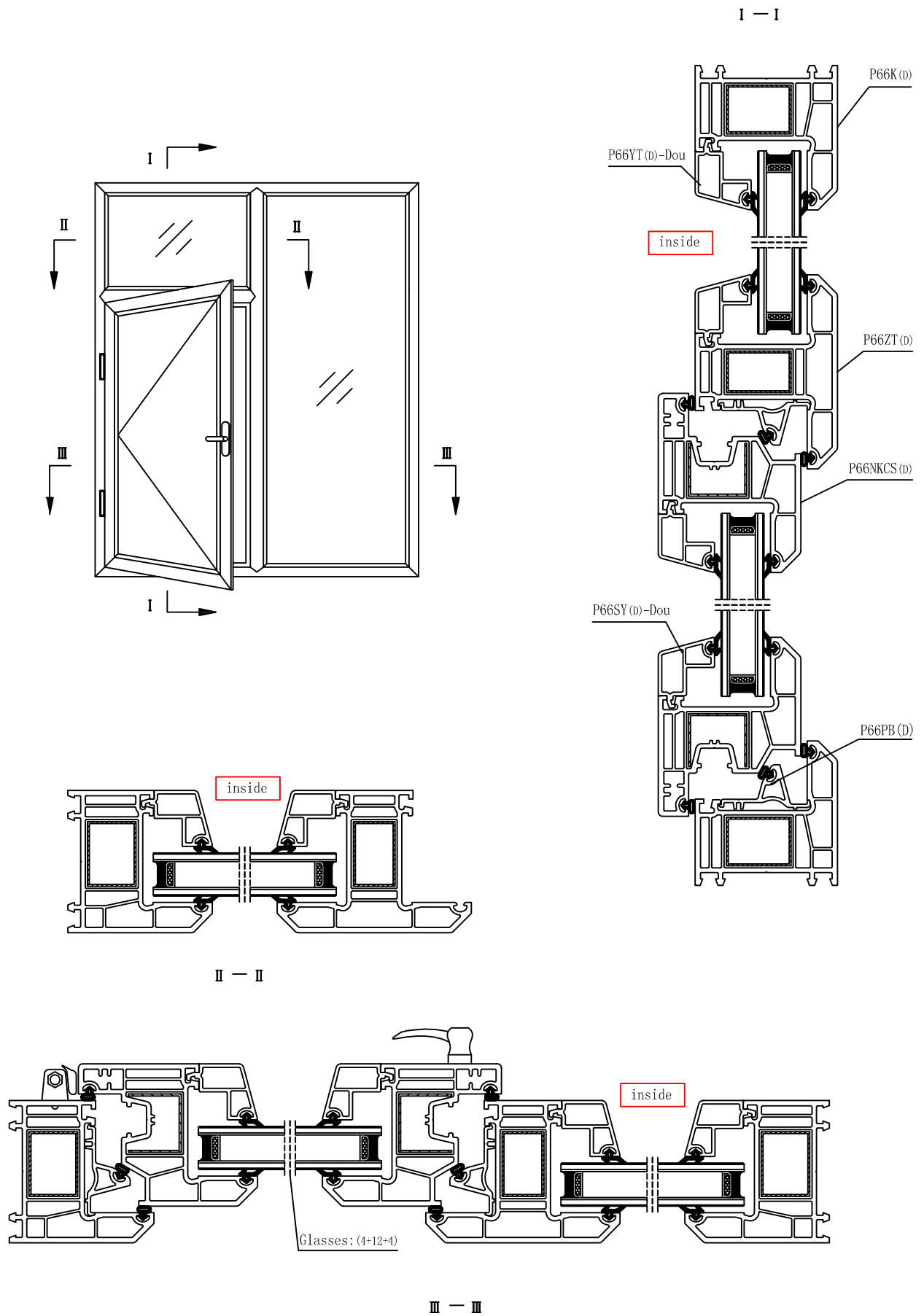

# 60series window's node drawing

## 60sliding door

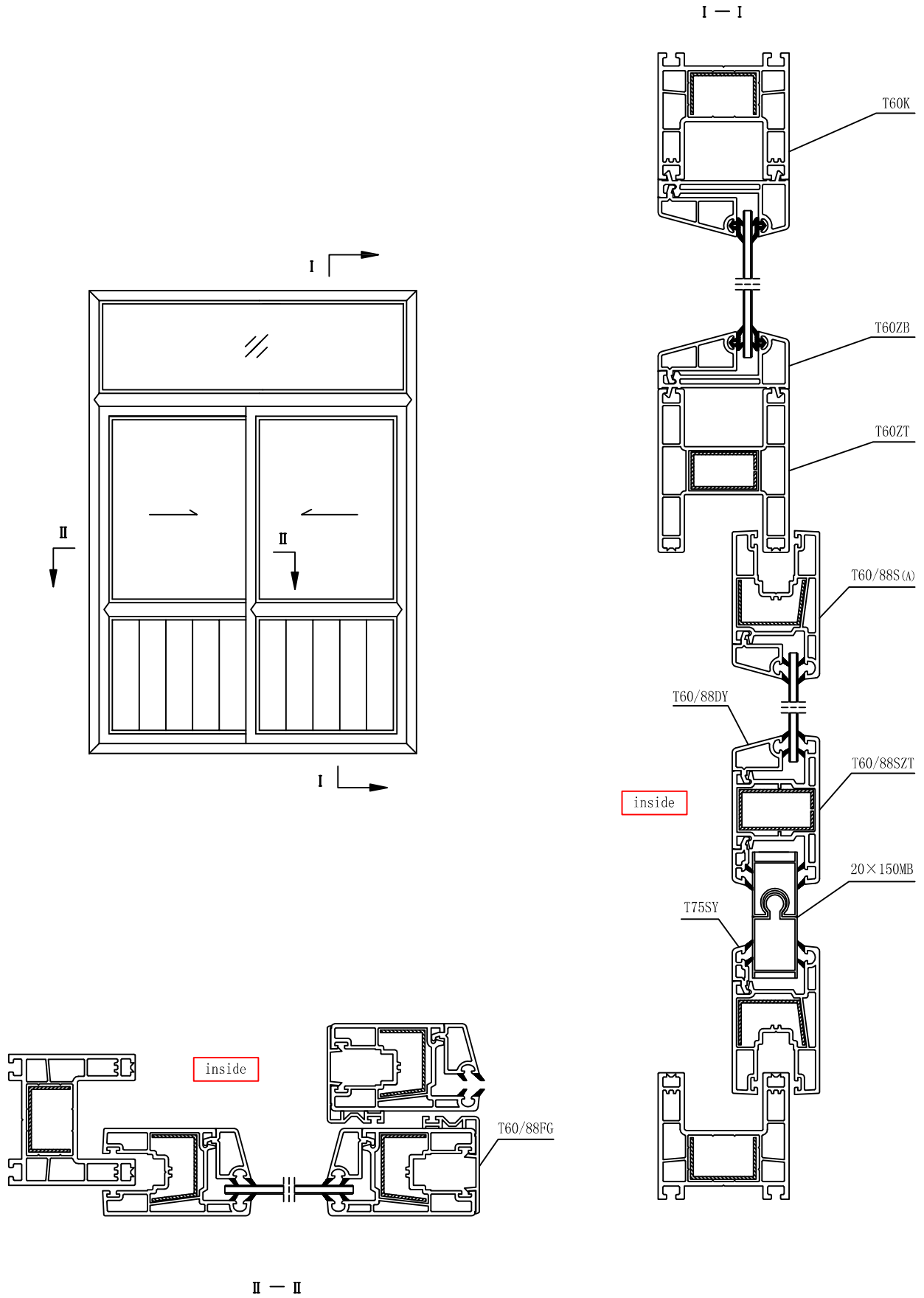



# 75series window's node drawing

## Fabricating picture for 75 sliding windows

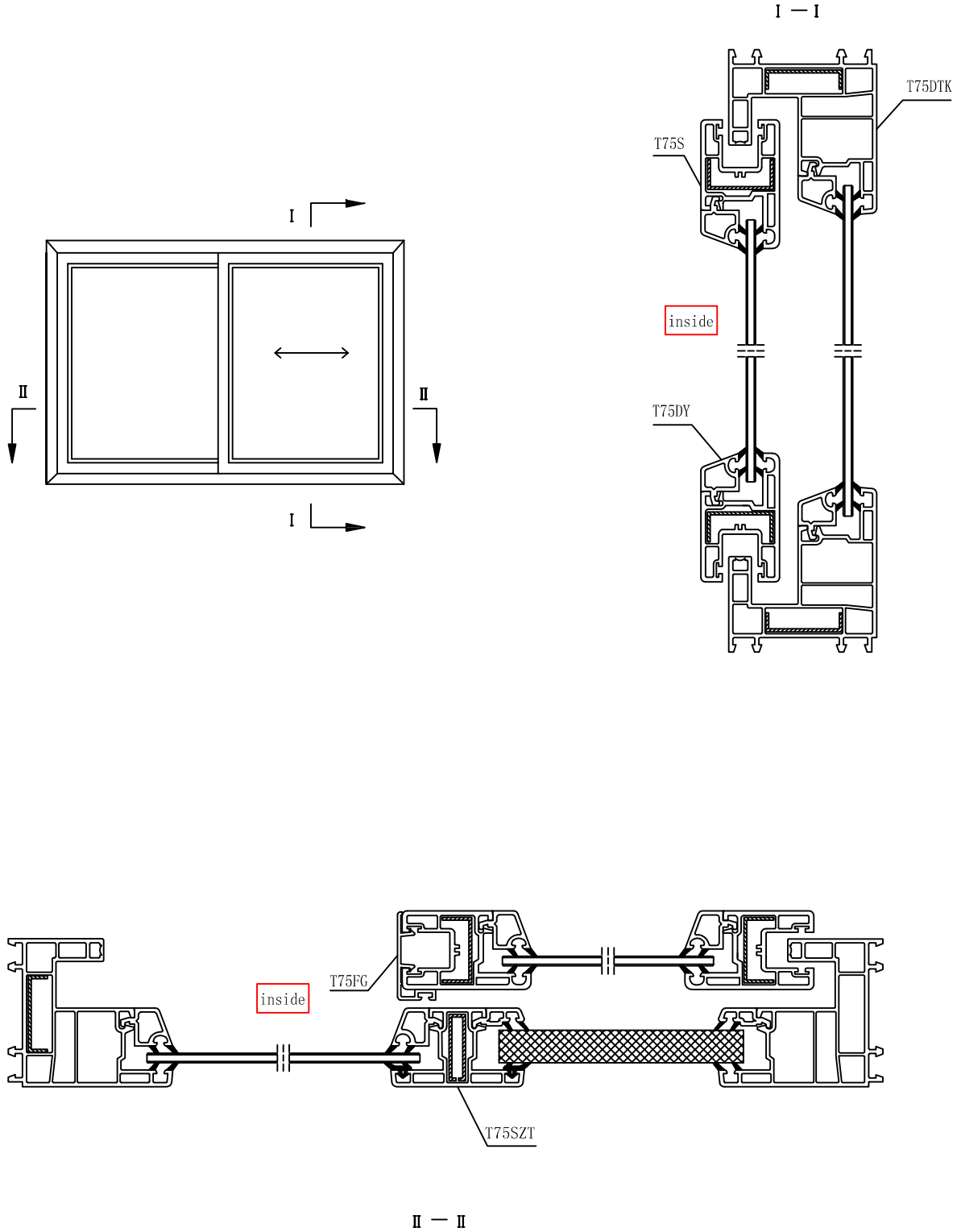

# 80series window's node drawing

## Fabricating picture for 80 sliding windows

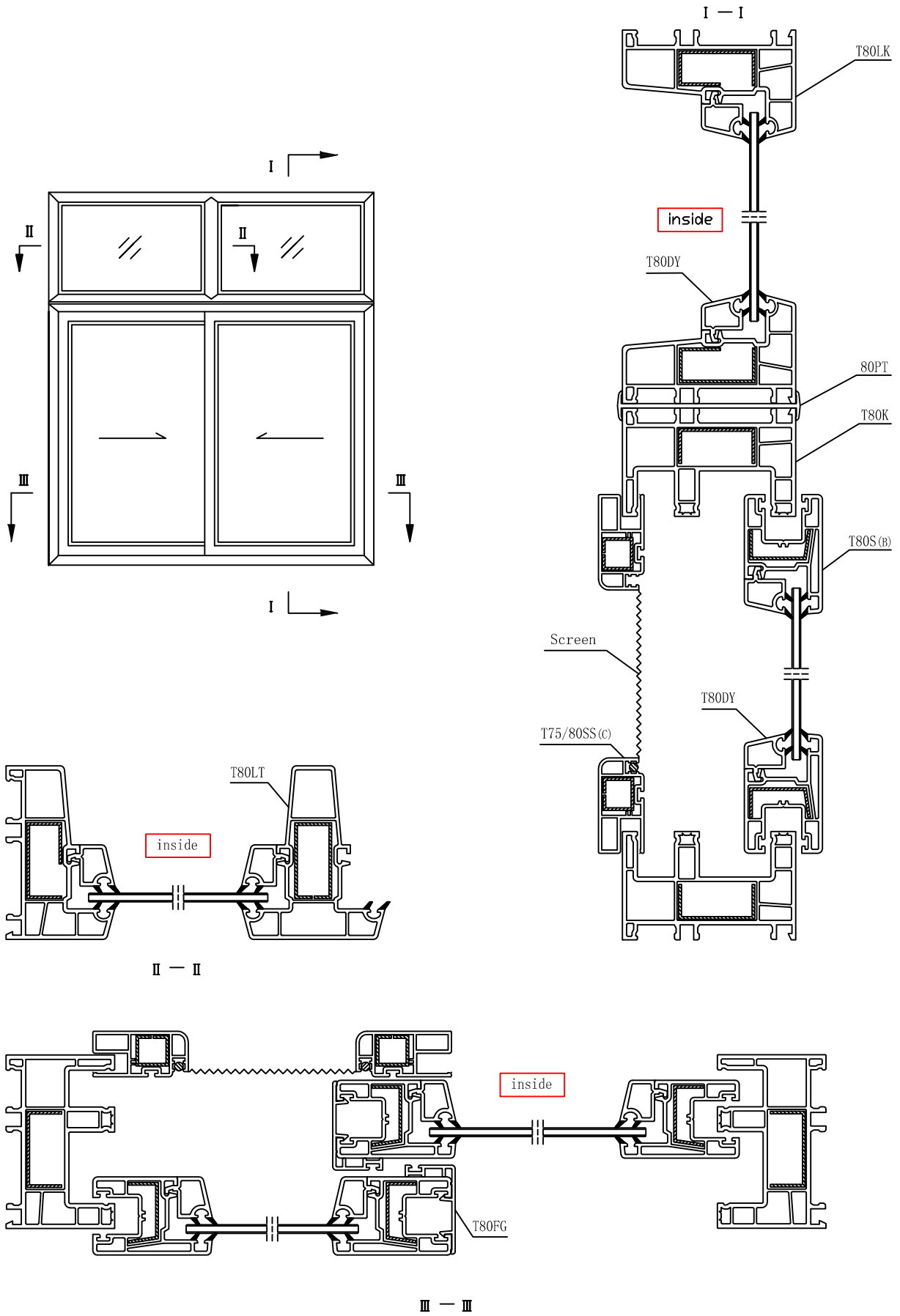

# 80series window's node drawing

## Fabricating picture for 80 sliding windows

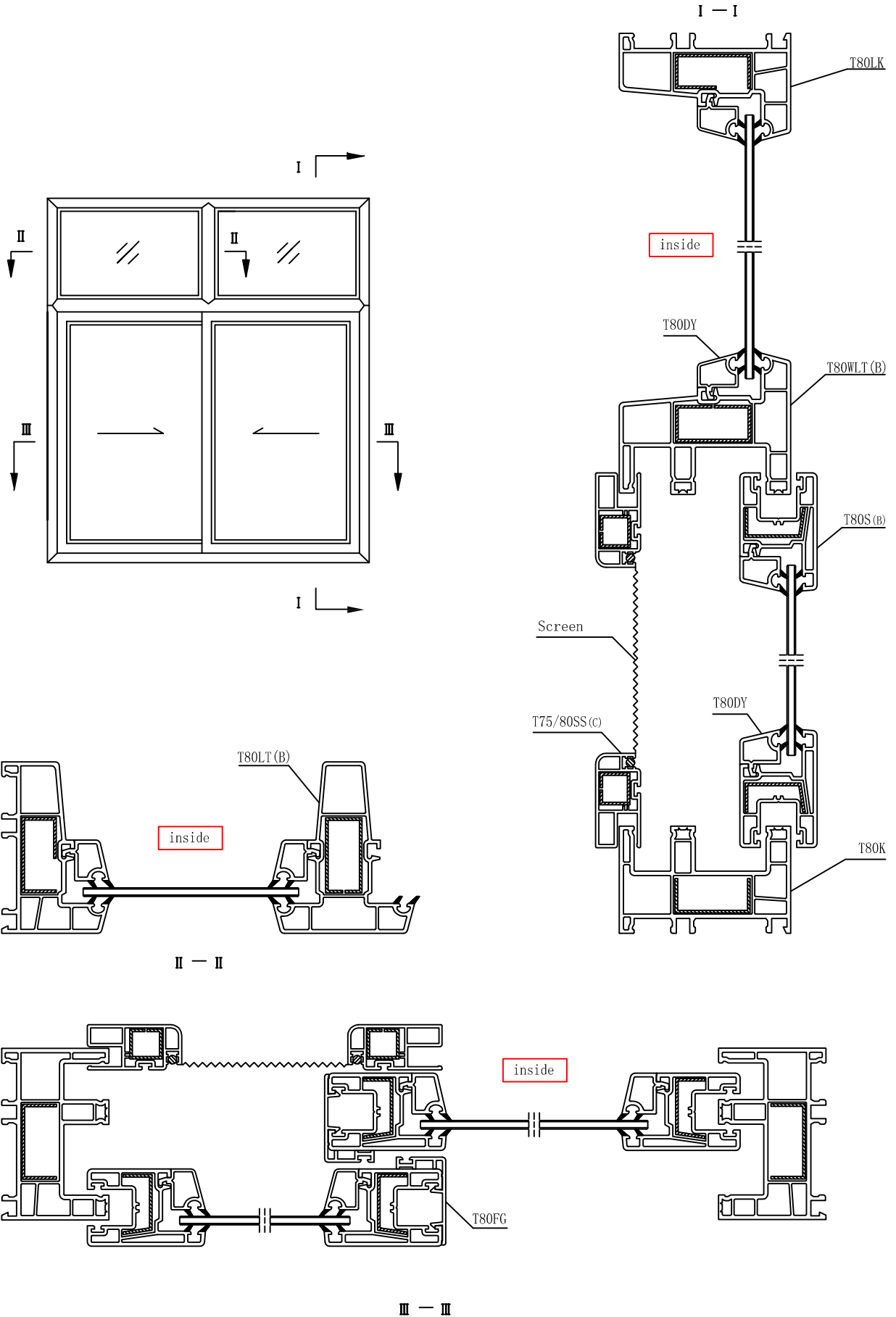

# 80series window's node drawing

Fabricating picture for 80 sliding windows

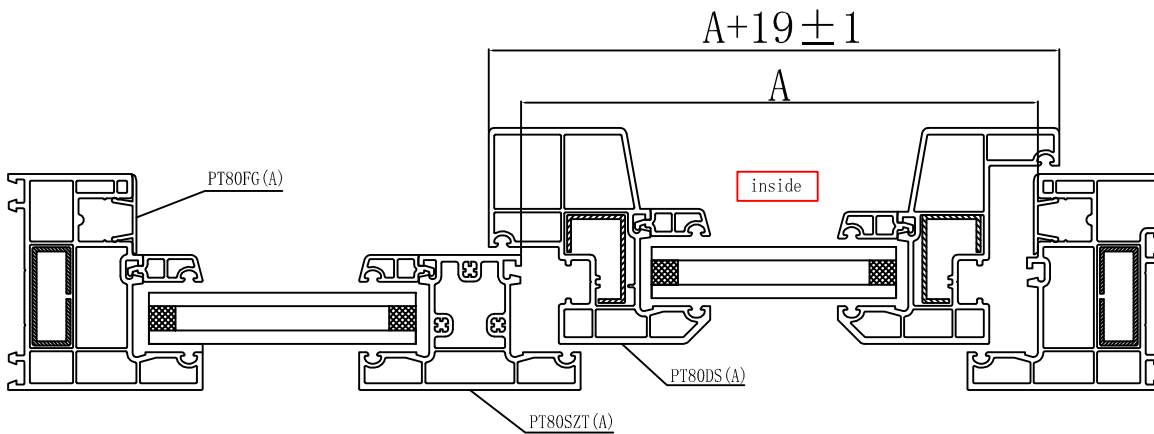
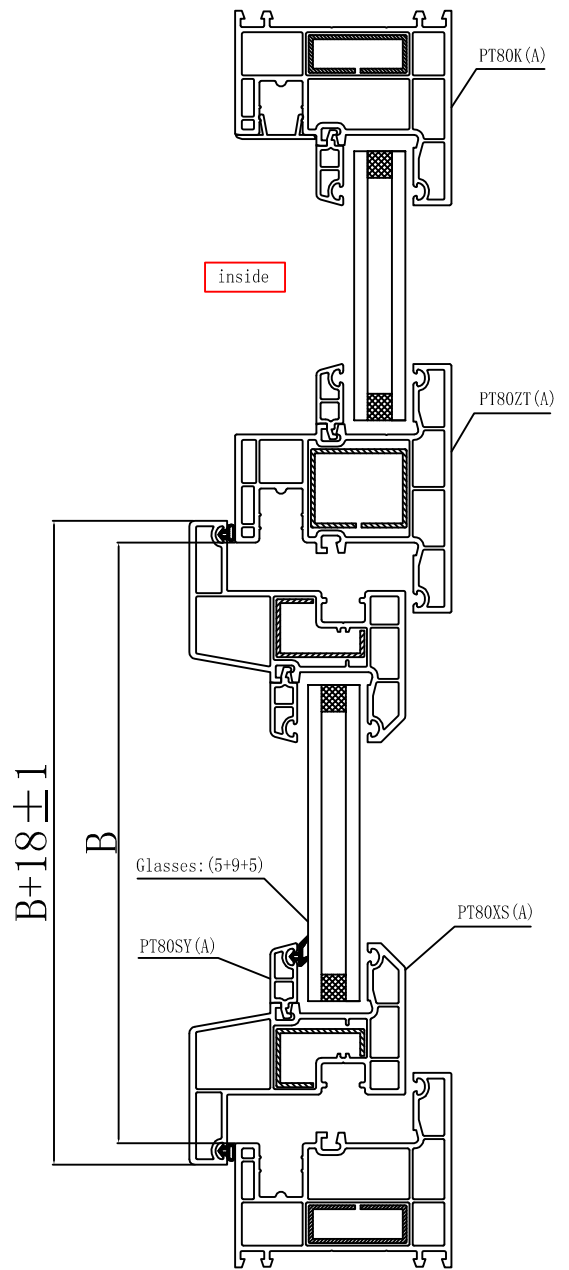
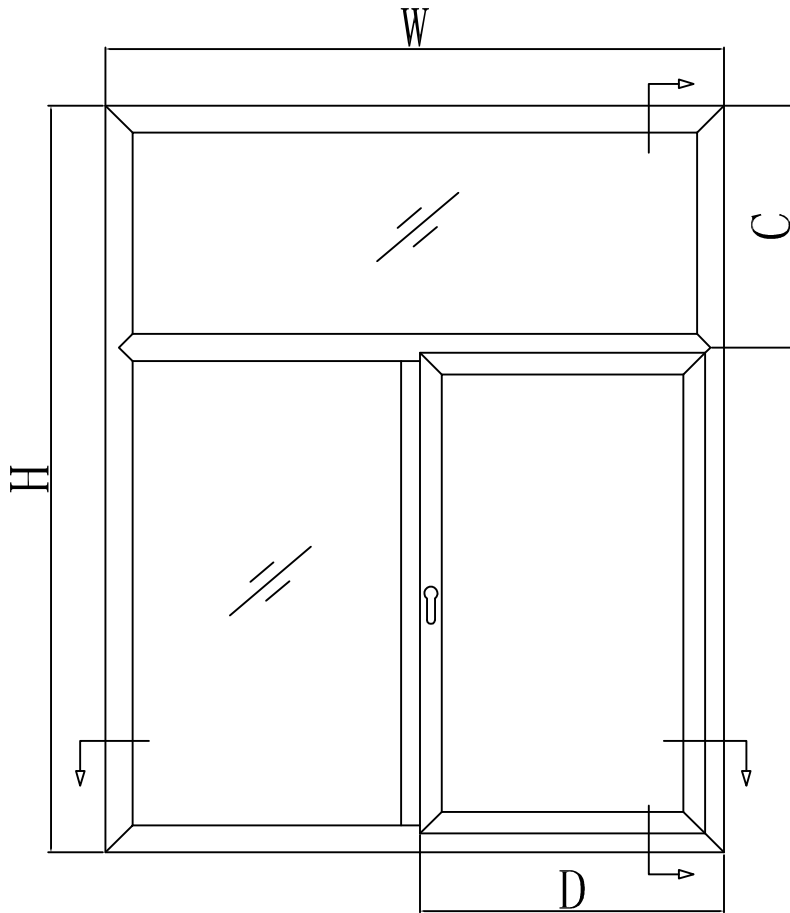

# 88series window's node drawing



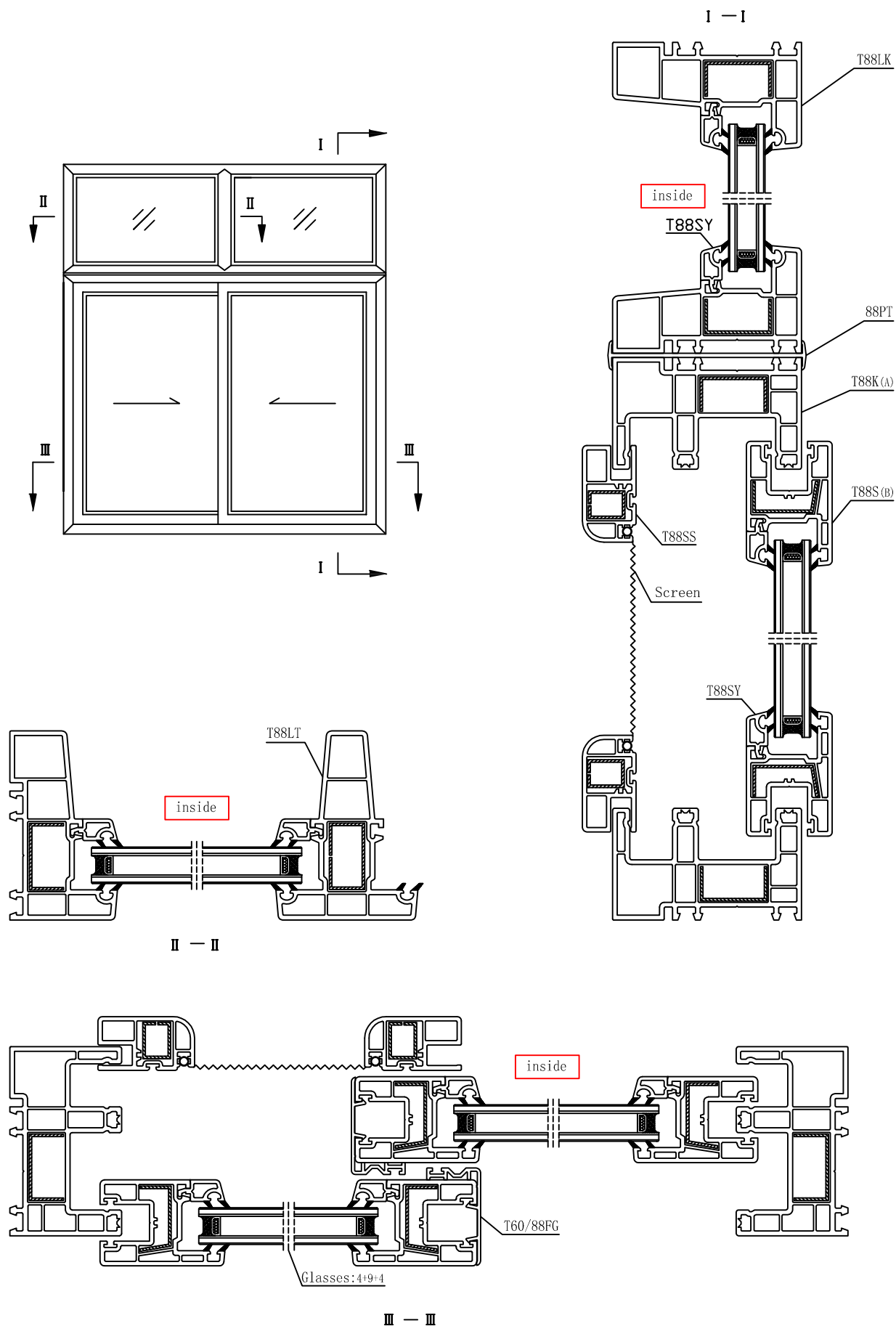





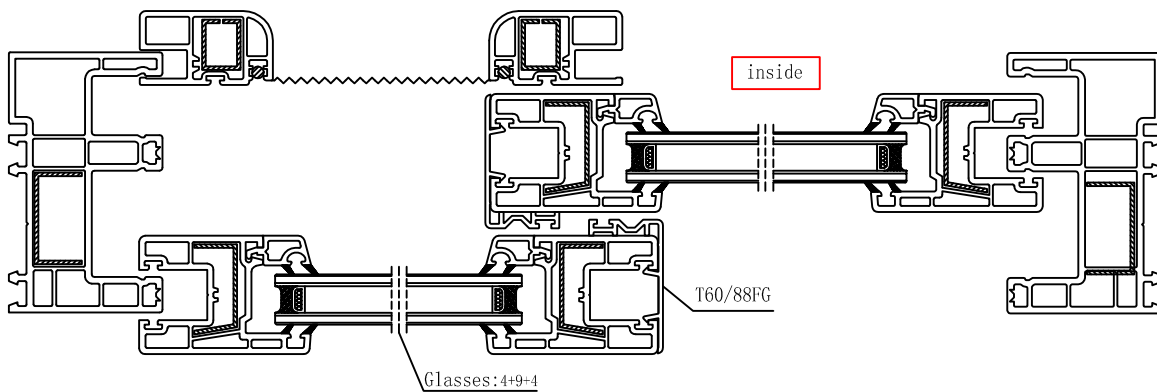
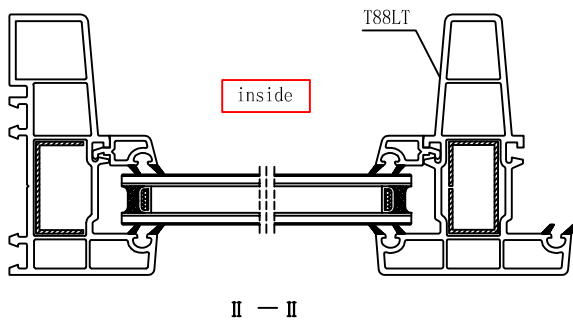
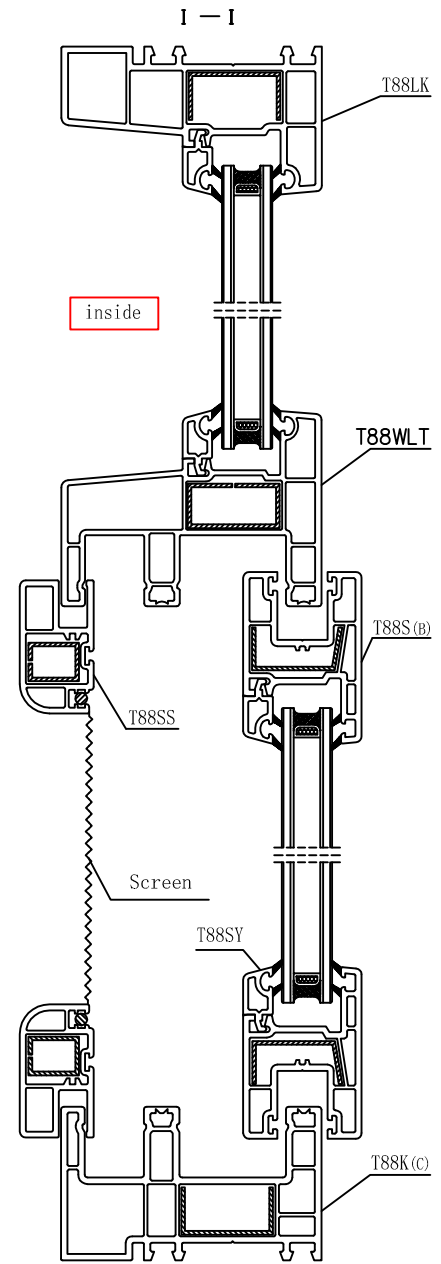
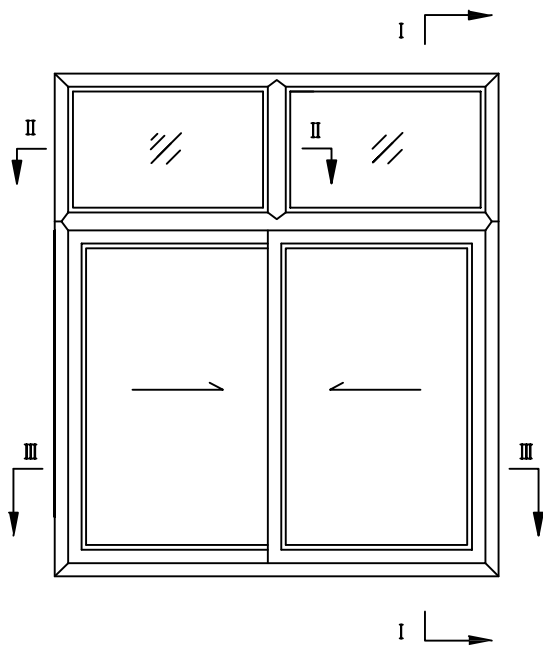











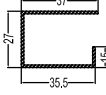



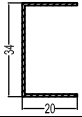

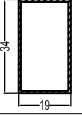

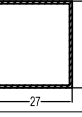



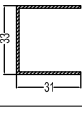

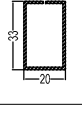
## Fabricating picture for 88-sliding windows

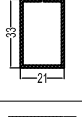

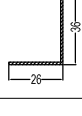

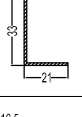











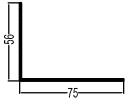

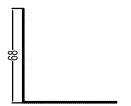

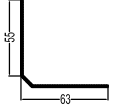

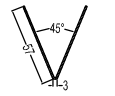

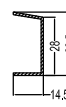
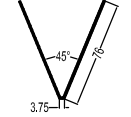

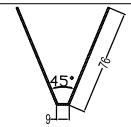

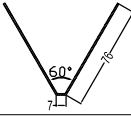
# 88series window's node drawing

## Fabricating picture for 88 slim windows

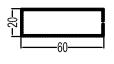

Drawings	Code	Drawings	Code	Drawings	Code
60 Opening Series		60 Opening Series (L)			P66K (D)
	P60K (A) P60K (E)		P60K (LA)		P66NKCS (D)
	P60K (B)		P60ZT (LA)		P66NKCS (D)
	P60K (C)		P60ZT (LB)		P66NKMS (D) P66WKMS (D)
	P60K (D)		P60NKCS (LB)	60 Sliding Series	
	P60ZT (A) P60ZT (B) P60ZT (E)	60 Opening Series (S)			T60K
	P60ZT (D)		P60K (S)		T60ZT
	P60NKCS (A) P60NKCS (B)		P60ZT (S)		T60S (B)
	P60WKCS		P60NKCS (S)		T60/88S (A)
	P60NKMS (A)	66 Opening Series			T60SZT
	P60NKMS (B)		P66K (A)	75 Sliding Series	
	P60MS		P66ZT (A)		T75DK
	P60WKMS		P66ZT (B)		T75S T75S (B)
	P60SS		P66NKCS (A)		T75SZT
	P42MS		P66K (B)		T75/80SS (B)
	P42SZT		P66NKCS (C)	80 Sliding Series	

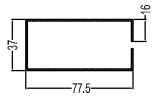
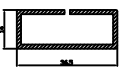
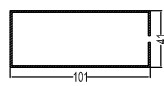
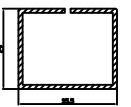
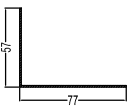
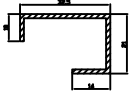
Drawings	Code	Drawings	Code	Drawings	Code
	T80K T80K (A) T80K (D)	88 Sliding Series			60ZJ (90°)
	T80LK T80LK (C)				T88K (A) T88LK
	T80LK (B)		T88K (B)		80/60ZJ (90°)
	T80LK (D)		T88K (C)		88ZJ (90°)
	T80WLT		T88LT		60/66FZJ (90°)
	T80LT		T88WLT		135° ZJ (60/66)
	T80LT (D)		T88S (B)		135° ZJ (80/88)
	T80S (A) T80S (D)		T88SS		135° ZJ
	T80S (B)		T88KS		120° ZJ
	T80S (C)	Spare Parts			60YG
	T80SZT				60PG
	T80/88SS (H)		80PG (20)		
80 Casement Sliding Series			88PG		
			80PG (40)		
	PT80K (A)		DPG		
	PT80ZT (A)		80/60ZJ (90°)		
	PT80XS (A) PT80DS (A)				